

OWNER'S MANUAL

LCD Color Television

16:9 WIDE COLORSTREAM®

VIRTUAL DOLBY SURROUND **SRS WOW**

26HL83

Owner's Record

The model number and serial number are on the back of your TV. Record these numbers in the spaces below. Refer to these numbers whenever you communicate with your Toshiba dealer about this TV.

Model number:

Serial number:

Dear Customer,

Thank you for purchasing this Toshiba TV. This manual will help you use the many exciting features of your new TV.

Before operating the TV, please read this manual completely, and keep it nearby for future reference.

Safety Precautions

WARNING

TO REDUCE THE RISK OF FIRE OR ELECTRIC SHOCK, DO NOT EXPOSE THIS APPLIANCE TO RAIN OR MOISTURE.



WARNING
RISK OF ELECTRIC SHOCK
DO NOT OPEN



WARNING: TO REDUCE THE RISK OF ELECTRIC SHOCK, DO NOT REMOVE COVER (OR BACK). NO USER-SERVICEABLE PARTS INSIDE. REFER SERVICING TO QUALIFIED SERVICE PERSONNEL.



The lightning symbol in the triangle tells you that the voltage inside this product may be strong enough to cause an electric shock. **DO NOT TRY TO SERVICE THIS PRODUCT YOURSELF.**



The exclamation mark in the triangle tells you that important operating and maintenance instructions follow this symbol.

WARNING

To prevent injury, this apparatus must be securely attached to the floor/wall in accordance with the installation instructions.

NOTE TO CATV INSTALLERS IN THE USA

This is a reminder to call the CATV system installer's attention to Article 820-40 of the NEC, which provides guidelines for proper grounding and, in particular, specifies that the cable ground shall be connected to the grounding system of the building, as close to the point of cable entry as practical. For additional antenna grounding information, see items 25 and 26 on page 4.

NOTICE OF POSSIBLE TV STAND INSTABILITY



DANGER: RISK OF SERIOUS PERSONAL INJURY OR DEATH!

Use the LCD Color TV only with the following optional TV stand or bracket, use with any other type of optional accessories may cause instability which could result in the possibility of injury.

This servicing instructions are for use by qualified service personnel only.

- Pedestal stand FPT-TS26E
- Angled wall-hanging bracket FPT-TA5

When installing the TV, leave a space of at least 4 inches around the TV.

Child Safety

It Makes A Difference Where Your TV Stands



Congratulations on your purchase! As you enjoy your new TV, keep these safety tips in mind:

The Issue

- If you are like most consumers, you have a TV in your home. Many homes, in fact, have more than one TV.
- The home theater entertainment experience is a growing trend, and larger TVs are popular purchases; however, they are not always supported on the proper TV stands.
- Sometimes TVs are improperly secured or inappropriately situated on dressers, bookcases, shelves, desks, audio speakers, chests, or carts. As a result, TVs may fall over, causing unnecessary injury.

Toshiba Cares!

- The consumer electronics industry is committed to making home entertainment enjoyable and safe.
- The Consumer Electronics Association formed the Home Entertainment Support Safety Committee, comprised of TV and consumer electronics furniture manufacturers, to advocate children's safety and educate consumers and their families about television safety.

Tune Into Safety

- One size does NOT fit all! Use appropriate furniture large enough to support the weight of your TV (and other electronic components).
- Use appropriate angle braces, straps, and anchors to secure your furniture to the wall (but never screw anything directly into the TV).
- Carefully read and understand the other enclosed instructions for proper use of this product.
- Do not allow children to climb on or play with furniture and TVs.
- Avoid placing any item on top of your TV (such as a VCR, remote control, or toy) that a curious child may reach for.
- Remember that children can become excited while watching a program and can potentially push or pull a TV over.
- Share our safety message about this hidden hazard of the home with your family and friends. Thank you!



2500 Wilson Blvd.
Arlington, VA 22201 U.S.A.
Tel. 703-907-7600 Fax 703-907-7690
www.CE.org

CEA is the Sponsor, Producer and Manager of the International CES®

Important Safety Instructions

- 1) **Read these instructions.**
- 2) **Keep these instructions.**
- 3) **Heed all warnings.**
- 4) **Follow all instructions.**



- 5) **Do not use this apparatus near water.**
- 6) **Clean only with dry cloth.**
- 7) **Do not block any ventilation openings.** Install in accordance with the manufacturer's instructions.

- 8) **Do not install near any heat sources** such as radiators, heat registers, stoves, or other apparatus (including amplifiers) that produce heat.

- 9) **Do not defeat the safety purpose of the polarized or grounding type plug.** A polarized plug has two blades with one wider than the other. A grounding type plug has two blades and a third grounding prong. The wide blade or the third prong are provided for your safety. If the provided plug does not fit into your outlet, consult an electrician for replacement of the obsolete outlet.

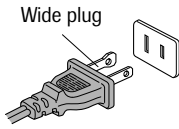

- 10) **Protect the power cord** from being walked on or pinched, particularly at plugs, convenience receptacles, and the point where they exit from the apparatus.

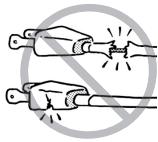

- 11) **Only use attachments/accessories specified by the manufacturer.**

- 12) **Use only with the cart, stand, tripod, bracket, or table specified by the manufacturer, or sold with the apparatus.** When a cart is used, use caution when moving the cart/apparatus combination to avoid injury from tip-over.



- 13) **Unplug this apparatus during lightning storms or when unused for long periods of time.**

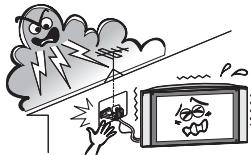

- 14) **Refer all servicing to qualified service personnel.** Servicing is required when the apparatus has been damaged in any way, such as power-supply cord or plug is damaged, liquid has been spilled or objects have fallen into the apparatus, the apparatus has been exposed to rain or moisture, does not operate normally, or has been dropped.

- 15) The apparatus shall not be exposed to dripping or splashing and that no objects filled with liquids, such as vases, shall be placed on the apparatus.

Installation, Care, and Service

Installation

Follow these recommendations and precautions and heed all warnings when installing your TV:

- 16) Never modify this equipment. Changes or modifications may void: a) the warranty, and b) the user's authority to operate this equipment under the rules of the Federal Communications Commission.

- 17) **DANGER: RISK OF SERIOUS PERSONAL INJURY, DEATH, OR EQUIPMENT DAMAGE!** Never place the TV on an unstable cart, stand, or table. The TV may fall, causing serious personal injury, death, or serious damage to the TV.



- 18) Never place or store the TV in direct sunlight; hot, humid areas; areas subject to excessive dust or vibration.

- 19) Always place the TV on the floor or a sturdy, level, stable surface that can support the weight of the unit. Use a sturdy tie between the TV's rear hook and the rear wall, pillar, etc., to secure the TV.

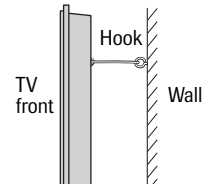

- 20) Never place items such as vases, aquariums, or candles on top of the TV.

- 21) Never block or cover the slots or openings in the TV cabinet back, bottom, and sides. Never place the TV:

- on a bed, sofa, rug, or similar surface;
- too close to drapes, curtains, or walls; or
- in a confined space such as a bookcase, built-in cabinet, or any other place with poor ventilation.

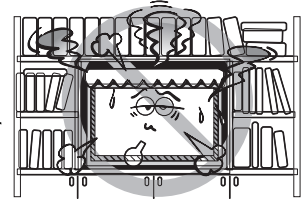

The slots and openings are provided to protect the TV from overheating and to help maintain reliable operation of the TV.

- 22) Never allow anything to rest on or roll over the power cord, and never place the TV where the power cord is subject to wear or abuse.

- 23) Never overload wall outlets and extension cords.

- 24) Always operate this equipment from 120V AC, 50/60Hz power source only.

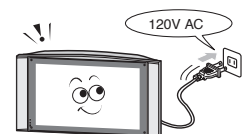

CAUTION: To reduce the risk of electric shock, do not use the polarized plug with an extension cord, receptacle, or other outlet unless the blades can be inserted completely to prevent blade exposure.

(continued on next page)

- 25) Always make sure the antenna system is properly grounded to provide adequate protection against voltage surges and built-up static charges (see Section 810 of the National Electric Code).

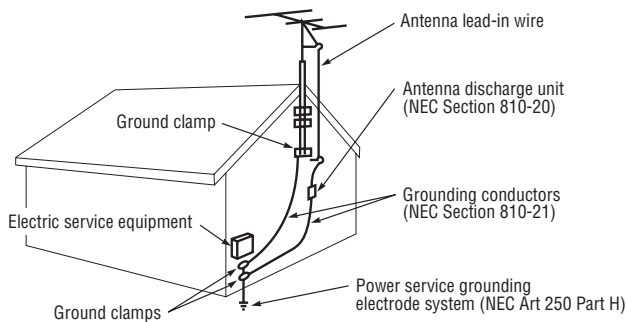

- 26) **! DANGER: RISK OF SERIOUS PERSONAL INJURY OR DEATH!**
- Use extreme care to make sure you are never in a position where your body (or any item you are in contact with, such as a ladder or screwdriver) can accidentally touch overhead power lines. Never locate the antenna near overhead power lines or other electrical circuits.
 - Never attempt to install any of the following during lightning activity:
 - a) an antenna system; or b) cables, wires, or any home theater component connected to an antenna or phone system.

Care

For better performance and safer operation of your TOSHIBA TV, follow these recommendations and precautions:

- 27) If you use the TV in the room of 0°C or less, the picture brightness may vary until the LCD monitor warms up. This is not a sign of a malfunction.

- 28) Always unplug the TV before cleaning. Wipe the display panel surface gently using only the supplied wiping cloth or a soft cloth (cotton, flannel, etc.). A hard cloth may damage the surface of the panel. Avoid contact with alcohol, thinner, benzene, acidic or and alkaline solvent cleaners, abrasive cleaners, or chemical cloths, as the surface may be impaired.

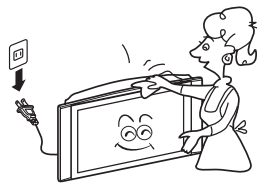

- 29) **! WARNING: RISK OF ELECTRIC SHOCK!** Never spill liquids or push objects of any kind into the TV cabinet slots.

- 30) While it is thundering, do not touch the connecting cables or apparatus.

- 31) If you have the LCD screen facing to the sun, the LCD screen will be damaged. Be aware of locating the TV in the place such as window side or outside of the room.

- 32) LCD (Liquid Crystal Display) may cause interference in image, sound, etc. of other electronic equipment that is easy to receive electromagnetic waves (i.e. AM radios and video equipment) under certain installed condition. In particular, it may affect electronic equipment beyond the residential unit where a LCD TV is used.

- 33) For added protection of your TV from lightning and power surges, always unplug the power cord and disconnect the antenna from the TV if you leave the TV unattended or unused for long periods of time.

- 34) During normal use, the TV may make occasional snapping or popping sounds. This is normal, especially when the unit is being turned on or off. If these sounds become frequent or continuous, unplug the power cord and contact a Toshiba Authorized Service Center.

- 35) **! The screen on this TV is manufactured from glass. To prevent damage, never strike the glass with a sharp or heavy object.**

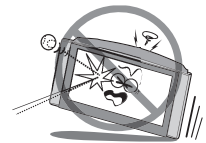

- 36) The LCD panel on this TV is manufactured using an extremely high level of precision technology; however, an occasional pixel (dot of light) may display constantly on the screen. This is a structural property of LCD technology and is not a sign of malfunction. Such pixels are not visible when the picture is viewed from a normal viewing distance.

Note: Interactive video games that involve shooting a “gun” type of joystick at on-screen target may not work on this TV.

Service

- 37) **! WARNING: RISK OF ELECTRIC SHOCK!** Never attempt to service the TV yourself. Opening and removing the covers may expose you to dangerous voltage or other hazards. Refer all servicing to a Toshiba Authorized Service Center.

- 38) If you have the TV serviced:

- Ask the service technician to use only replacement parts specified by the manufacturer.
- Upon completion of service, ask the service technician to perform routine safety checks to determine that the TV is in safe operating condition.

- 39) Cold cathode fluorescent lamp is LCD panel contains a small amount of mercury. When the TV reaches the end of its useful life, ask a qualified service technician to properly dispose of the TV, or follow local ordinances or regulations for disposal.

Introduction	6	Freezing the POP picture	39
Welcome to Toshiba	6	Adjusting the size of the double-window	39
Supplied accessories	6	Double-Window with keeping aspect ratio	40
Note Regarding Quick Connect Guide	6	Using the programmed channel search function	40
Exploring your new TV	7	Using the favorite channel search function	41
Connecting your TV	8	About the auto favorite feature	41
Connecting a VCR	9	Using the LOCKS menu	42
Connecting a cable converter box	9	Entering the PIN code	42
Connecting a cable converter box and VCR	10	If you cannot remember your PIN code	42
Connecting a DVD player or satellite receiver and a VCR	11	Using the V-CHIP menu	43
Connecting a DVD player with ColorStream® (component video) and a VCR	12	ENABLE BLOCKING	43
Connecting a DTV receiver/set-top box with ColorStream® (component video) and a VCR	13	TV RATING (Independent rating system for broadcasters)	43
Connecting two VCRs	14	MPAA RATING (Independent rating system for movies)	44
Connecting a camcorder	14	BLOCKING OPTION	44
Connecting a device to the DVI/HDCP	15	Unlocking programs temporarily	45
Connecting a device to the TheaterLink	16	Locking channels	45
Connecting an audio system	17	Locking video inputs	46
Using the remote control	18	Using the game timer	47
Preparing the remote control for use	18	Using the front panel lock feature	47
Installing the remote control batteries	18	Changing the PIN code	47
Remote Control functional key chart	19	Adjusting the picture	48
Programming the remote control for use with your audio/video devices	21	Selecting the picture mode	48
Device code setup	21	Adjusting the picture quality	48
Searching and sampling the code of a device (8500)	21	Saving your new preferences	49
Using the volume lock feature (8000)	22	Using CableClear™ DNR (Digital Noise Reduction)	49
Operational feature reset (8900)	22	Selecting the color temperature	49
Device code table	23	Resetting your picture quality adjustments	50
Learning about the remote control	25	Selecting the video input source	50
Setting up your TV	26	Labeling the video input sources	51
Learning about the menu system	26	Selecting the background of the menu display	51
Using the Quick Connect Guide	27	Using the closed caption feature	52
Changing the on-screen display language	28	Setting the ON-timer	53
Selecting the antenna input	28	Setting the sleep timer	53
Adding channels to the TV's memory	29	Adjusting the sound	54
Programming channels automatically	29	Muting the sound	54
Adding and erasing channels manually	30	Selecting stereo/SAP broadcasts	54
Changing channels	30	Enjoying the Dolby Virtual sound feature	55
Changing channels using SpeedSurf	30	Enjoying the WOW™ surround sound feature	55
Using the TV's features	31	Adjusting the sound quality	56
Adjusting the channel settings	31	Resetting your audio adjustments	56
Switching between two channels using Channel Return	31	Using the sub-bass system (SBS)	57
Switching between two channels using SurfLock™	31	Turning off the built-in speakers	57
Programming your favorite channels	31	Selecting the Audio OUT sound	58
Labeling channels	33	Using the StableSound® feature	58
Viewing the wide-screen picture formats	34	Selecting the gray level of the side panels	59
Selecting the picture size	34	Adjusting the back lighting feature	59
Scrolling the Theater Wide picture (Theater Wide 2 and 3 only)	36	Displaying on-screen information	60
Using the auto aspect feature	37	Viewing the demonstration mode	60
Selecting the cinema mode	37	Understanding the auto power off feature	60
Using the POP double-window feature	38	Understanding the last mode memory feature	60
Switching the main and POP pictures	39	Appendix	61
		Specifications	61
		Troubleshooting	62
		Limited United States Warranty for LCD TV	63
		Limited Canada Warranty for LCD TV	64
		Index	65

Introduction

Welcome to Toshiba

Congratulations! You have purchased one of the finest LCD TVs on the market. The goal of this manual is to guide you through setting up and operating your Toshiba TV as quickly as possible.

The model and serial numbers are on the back of your TV. Write these numbers in the space provided on the front cover of this manual for your records.

Instructions in this manual are based on using the remote control. You also can use the controls on the TV if they have the same name as those referred to on the remote control.

Please read all the safety and operating instructions carefully, and keep this manual for future reference.

Note Regarding Quick Connect Guide

The **Quick Connect Guide** automatically appears on-screen the first time the TV is turned on. This feature provides on-screen instructions to guide you through the initial setup of your TV.

To stop the **Quick Connect Guide**, either press **EXIT** or turn off the TV.

See page 27 for details.

Supplied accessories

Check that you have the accessories and items shown.

Owner's Manual

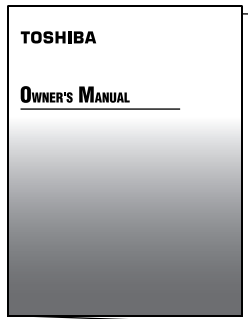

Remote control
CT-90164

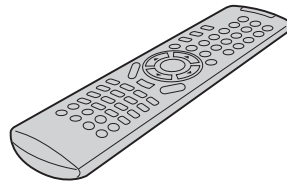

Batteries for the remote control
LR6 (AA) x 2

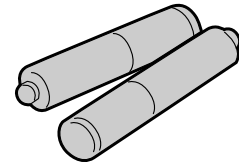

TheaterLink cable

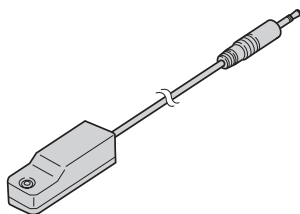

Soft cloth for cleaning the screen

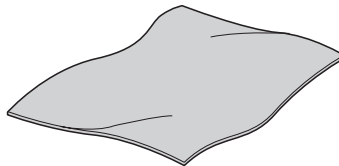

Exploring your new TV

You can operate your TV using the buttons on the front panel or the remote control. The A/V terminals for connecting other equipment to your TV are on the back panel and inside the storage compartment (see illustrations below). Also see "Connecting your TV" on pages 8-17.

Remote control

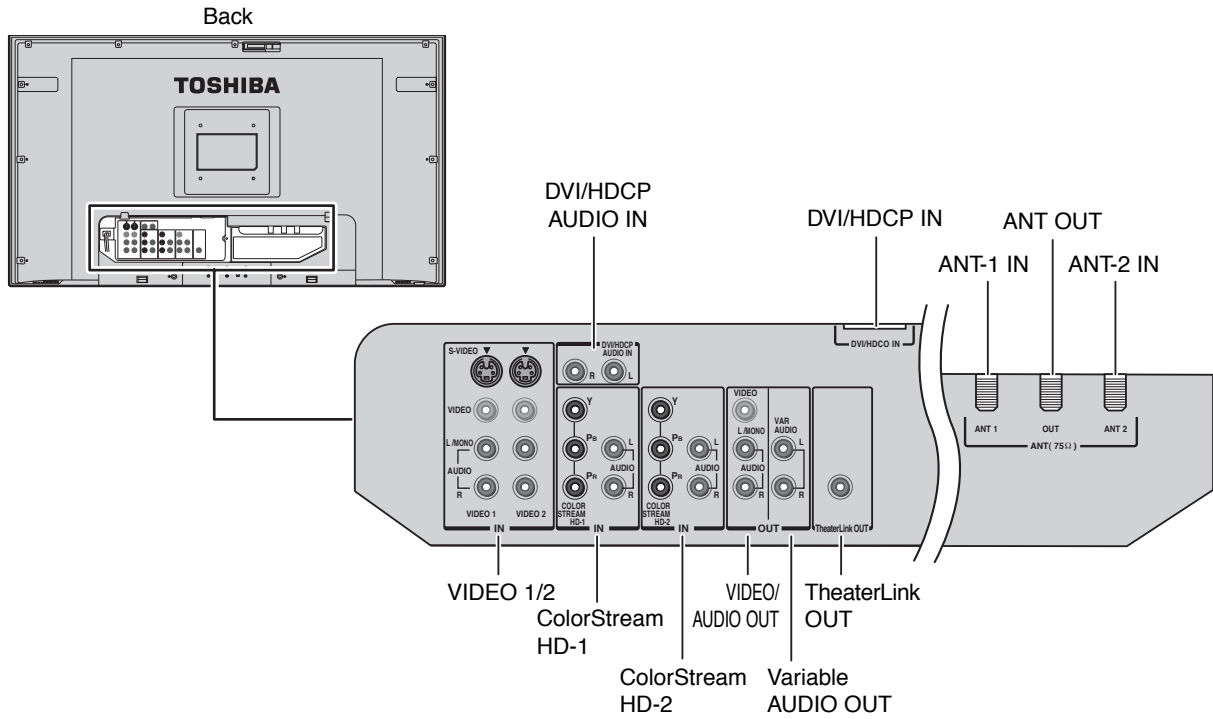
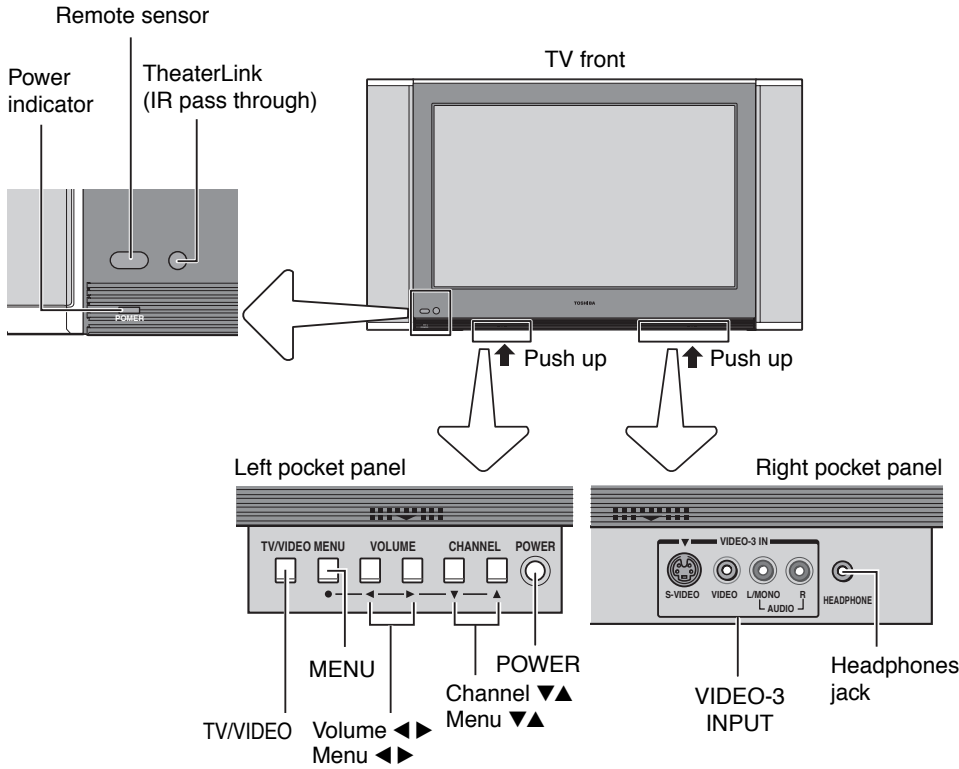
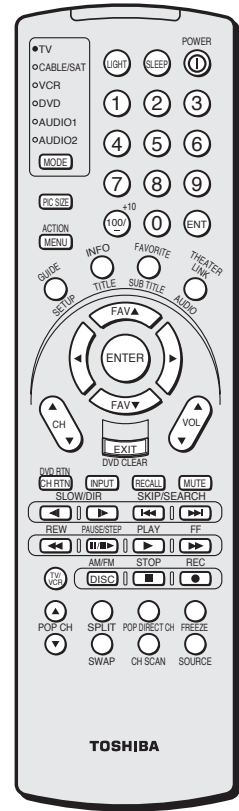

Connecting your TV

Note: One TheaterLink cable is provided with your TV. No other cables are provided.

- **Coaxial cable** is the cable that comes in from your antenna, cable TV service, or cable converter box. Coaxial cable has “F” connectors.
- **Standard stereo A/V cables** usually come in sets of three, and are typically color-coded according to use: yellow for video, red for stereo right audio, and white for stereo left (or mono) audio. Your TV’s standard A/V inputs are color-coded in the same manner as the cables.
- **S-video cable** is for use with video equipment that has an S-Video connector.
- **Component video cables** come in sets of three (typically color-coded red, green, and blue), and are for use with video equipment that has component video connectors. Your TV’s ColorStream® (component video) inputs are color-coded in the same manner as the cables.
- **DVI-D digital single-link cable** is for use with video equipment that has a DVI-D digital single-link connector (see page 15).
- **TheaterLink cable** is used to remotely control other A/V equipment (equipped with an infrared sensor) through the TV (see page 16).

NOTE REGARDING PICTURE QUALITY

When connecting video equipment to your Toshiba TV:

- **For GOOD picture quality:** Use a **standard stereo A/V (yellow) video** cable.
- **For BETTER picture quality:** If your equipment has an **S-video** connector, use an S-video cable *instead of* a standard yellow video cable. (You still must connect the standard red and white audio cables for full system connection, but *do not connect a standard yellow video cable at the same time* or the picture performance will be unacceptable.)
- **For BEST picture quality:** If your equipment has **component video** connectors, use component video cables *instead of* a standard yellow video cable or an S-video cable (plus the standard red and white audio cables for full system connection.) If your equipment has a **DVI-D digital single-link connector**, use a DVI-D cable (plus standard red and white audio cables connected to the audio terminals labeled “For DVI/HDCP IN” for full system connection).

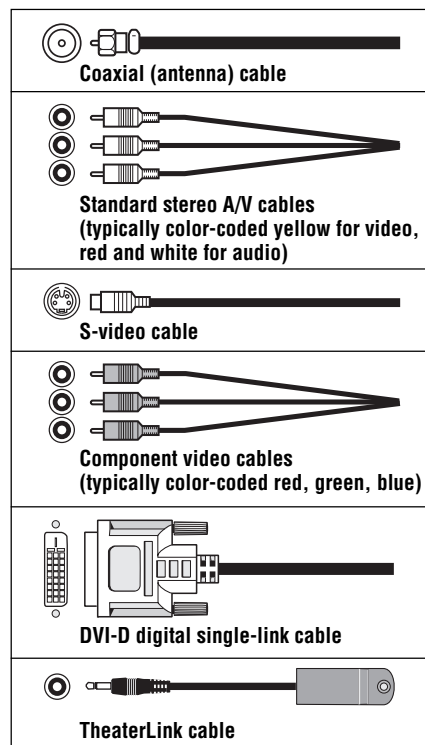

CAUTION:

Do not plug in any power cords until you have finished connecting all equipment.

Connecting a VCR

This connection allows you to watch local channels and video programs, watch video tapes, and record one channel while watching another channel.

You will need:

- two coaxial cables
- one set of standard A/V cables

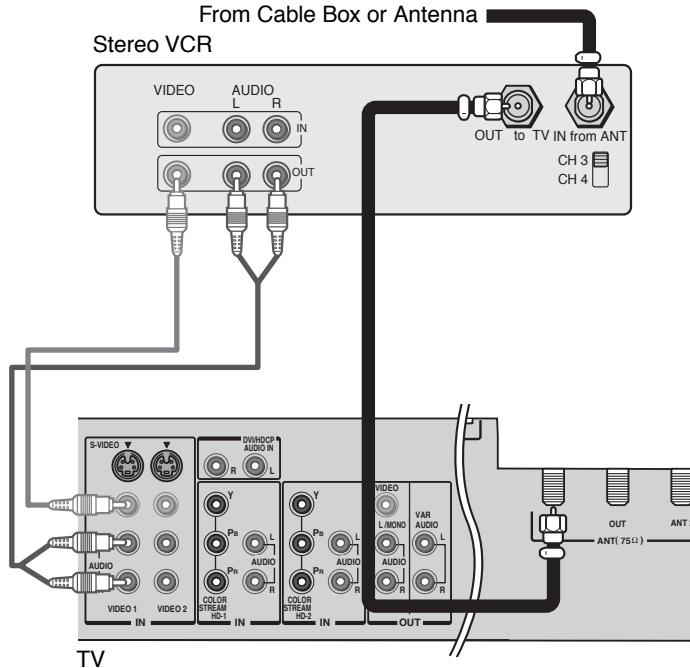

Note:

If you have a mono VCR, connect L/Mono to VCR Audio OUT using only one audio cable.

If you have a VCR with S-video, use an S-video cable instead of the standard video cable.

The unauthorized recording, use, distribution, or revision of television programs, videotapes, DVDs, and other materials is prohibited under the Copyright Laws of the United States and other countries, and may subject you to civil and criminal liability.

Connecting a cable converter box

This connection allows you to watch basic and premium cable channels.

To use the TV's features, select ANT-1. To view premium channels, select ANT-2, tune the TV to channel 3 or 4 (whichever channel is vacant in your area), and use the converter box to change channels.

You will need:

- three coaxial cables

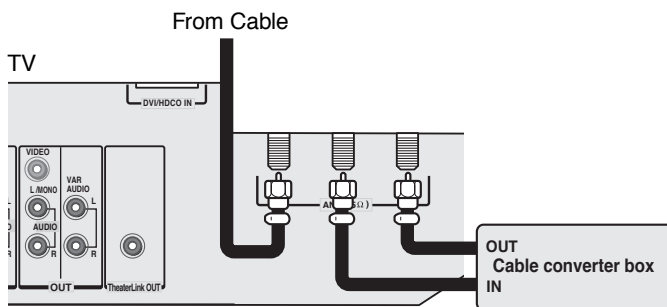

Note:

When you use a converter box with your TV, the remote control will not operate some features, such as programming your favorite channels, labeling channels, and locking channels.

Connecting a cable converter box and VCR

This connection allows you to watch and record basic and premium cable channels, watch videotapes, and record one channel while watching another channel. To use the TV's features, select ANT-1. To view premium channels or record with the VCR, select ANT-2, tune the TV and VCR to channel 3 or 4 (whichever channel is vacant in your area), and use the converter box to change channels.

You will need:

- one cable signal splitter
- five coaxial cables
- one set of standard A/V cables

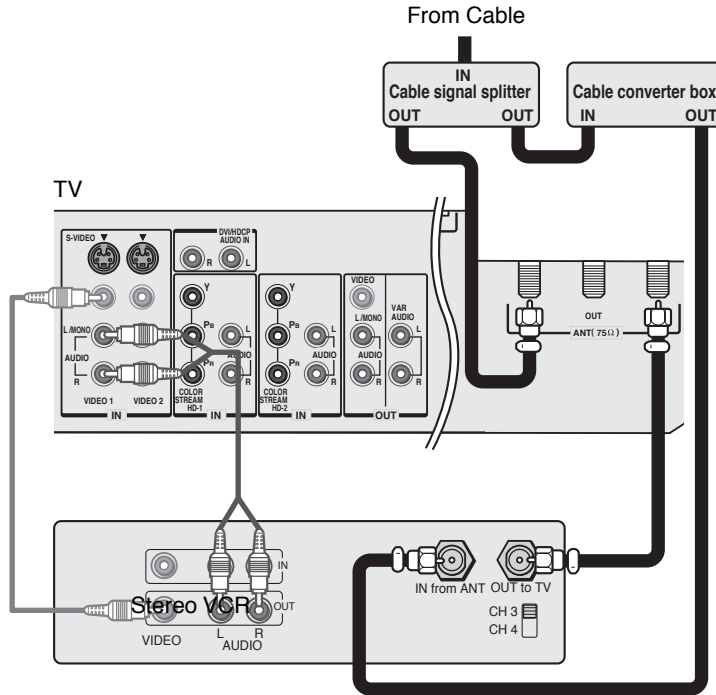

Note:

If you have a mono VCR, connect L/Mono to VCR Audio OUT using only one audio cable.

If you have a VCR with S-video, use an S-video cable instead of a standard video cable.

When you use a converter box with your TV, the remote control will not operate some features, such as programming your favorite channels, labeling channels, and locking channels.

The unauthorized recording, use, distribution, or revision of television programs, videotapes, DVDs, and other materials is prohibited under the Copyright Laws of the United States and other countries, and may subject you to civil and criminal liability.

Connecting a DVD player or satellite receiver and a VCR

This connection allows you to watch DVD/satellite, VCR, and TV programs, and record one channel while watching another channel.

You will need:

- two (or three, if satellite receiver is used) coaxial cables
- one set of standard A/V cables (between the TV and VCR) (plus one additional set of standard A/V cables if satellite receiver is used)
- one S-video cable (between the TV and DVD player/satellite receiver)
- one pair of standard audio cables (between the TV and DVD player/satellite receiver)

Note:

For the highest possible picture quality from a DVD player/satellite receiver without component video or DVI/HDCP, use an S-video cable between the TV and DVD player/satellite receiver. (If your DVD player/satellite receiver is compatible with component video, see page 13. If your DVD player/satellite receiver is compatible with DVI/HDCP, see page 16).

Do not connect the DVD player/satellite receiver and VCR to the same video channel on the TV. (See the illustrations, which show the DVD player/satellite receiver connected to VIDEO 1 on the TV and the VCR connected to VIDEO 2 on the TV.)

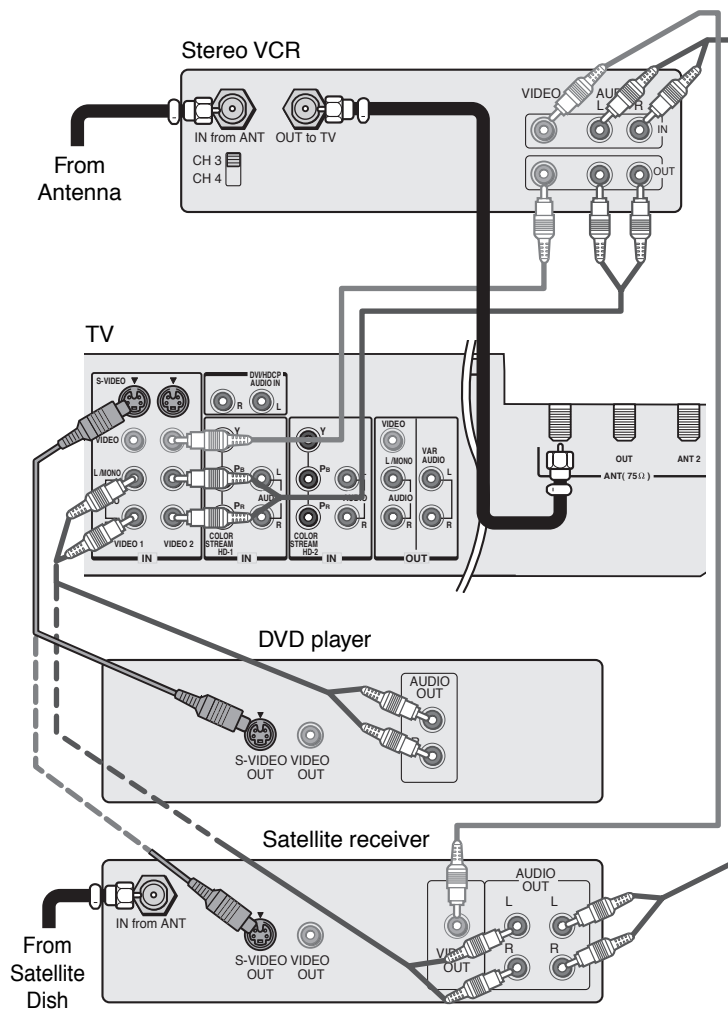

The unauthorized recording, use, distribution, or revision of television programs, videotapes, DVDs, and other materials is prohibited under the Copyright Laws of the United States and other countries, and may subject you to civil and criminal liability.

Connecting a DVD player with ColorStream® (component video) and a VCR

This connection allows you to watch DVD, VCR, and TV programs, and record TV programs. You can record one channel while watching another channel.

Your TV has ColorStream® (component video) inputs. Connecting your TV to a DVD player with component video (such as a Toshiba DVD player with ColorStream®) can greatly enhance picture quality and realism.

You will need:

- two coaxial cables
- one set of standard A/V cables
- one set of component video cables
- one pair of standard audio cables

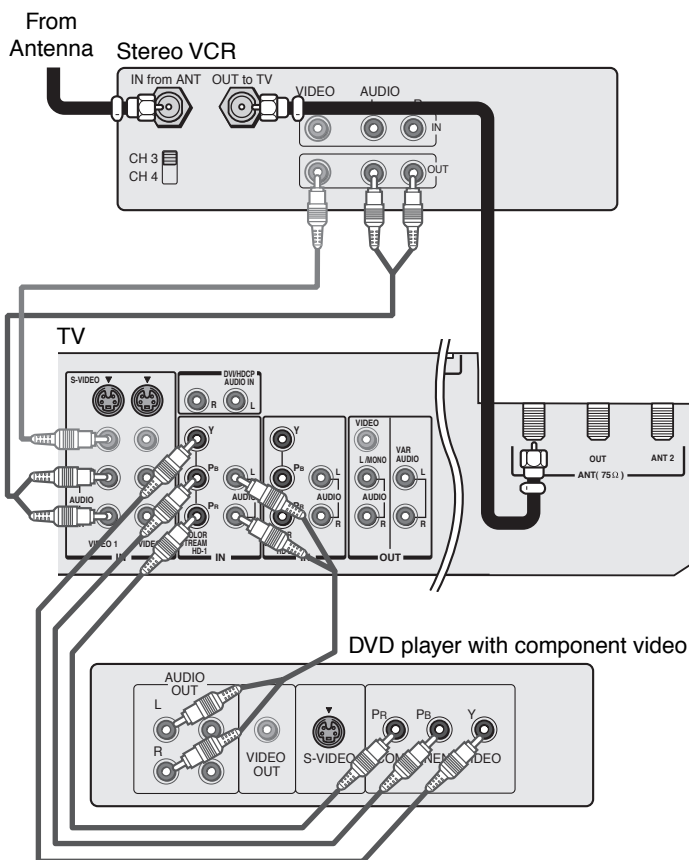

Note:

For the highest possible picture quality, use component video cables (or a DVI-D digital single-link cable) between the TV and DVD player.

You can connect component video cables from the DVD player to either set of ColorStream terminals on the TV (HD-1 or HD-2).

The ColorStream HD-1 and HD-2 terminals can be used with Progressive (480p, 720p) and Interlaced (480i, 1080i) scan systems.

If your DVD player is not compatible with component video (or DVI/HDCP), use an S-video cable (plus an audio connection) instead.

The unauthorized recording, use, distribution, or revision of television programs, videotapes, DVDs, and other materials is prohibited under the Copyright Laws of the United States and other countries, and may subject you to civil and criminal liability.

Connecting a DTV receiver/set-top box with ColorStream® (component video) and a VCR

This connection allows you to watch DTV (digital TV broadcast), VCR, and TV programs, and record DTV and TV programs. You can record from one source while watching a program from another source.

Your TV has ColorStream® (component video) inputs. Connecting your TV to a DTV receiver with component video can greatly enhance picture quality and realism.

You will need:

- three coaxial cables
- two sets of standard A/V cables
- one set of component video cables
- one pair of standard audio cables

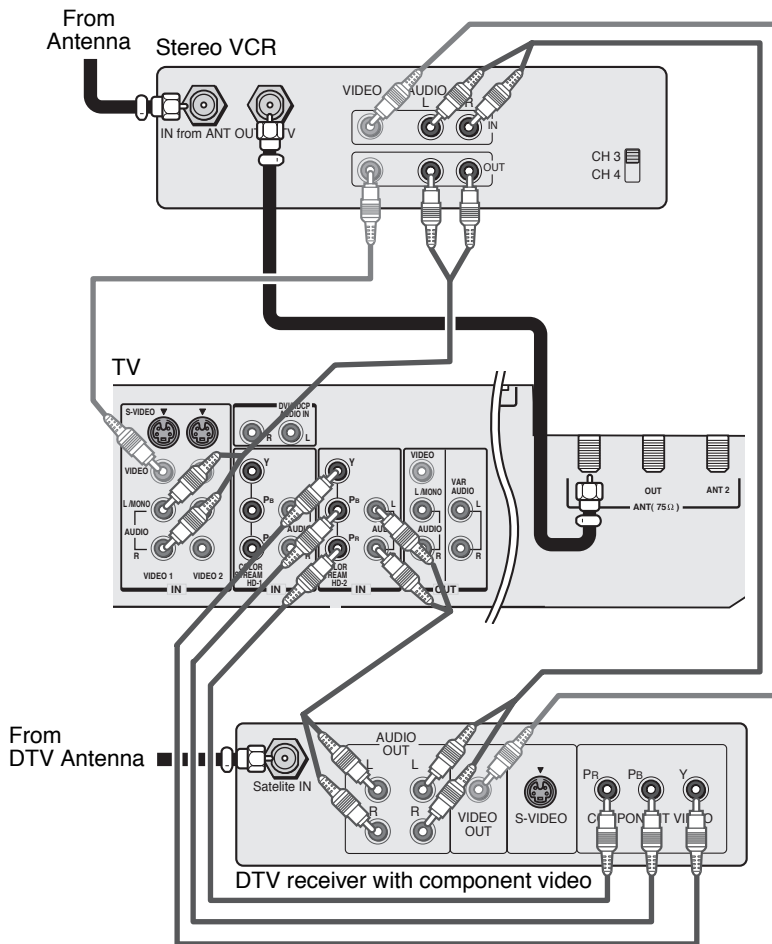

Note:

For the highest possible picture quality, use component video cables (or a DVI-D digital single-link cable) between the TV and DTV receiver.

You can connect component video cables from the DTV receiver to either set of ColorStream terminals on the TV (HD-1 or HD-2).

The ColorStream HD-1 and HD-2 terminals can be used with Progressive (480p, 720p) and Interlaced (480i, 1080i) scan systems.

If your DTV receiver is not compatible with component video (or DVI/HDCP), use an S-video cable (plus an audio connection) instead.

To record from the DTV receiver, set the VCR to Line IN. To monitor recording from the DTV receiver, set the VCR to Line IN and the TV to VIDEO 1.

The unauthorized recording, use, distribution, or revision of television programs, videotapes, DVDs, and other materials is prohibited under the Copyright Laws of the United States and other countries, and may subject you to civil and criminal liability.

Connecting two VCRs

This connection allows you to record (dub/edit) from one VCR to another VCR while watching a videotape. You also can record one channel while watching another channel.

You will need:

- two coaxial cables
- two sets of standard A/V cables

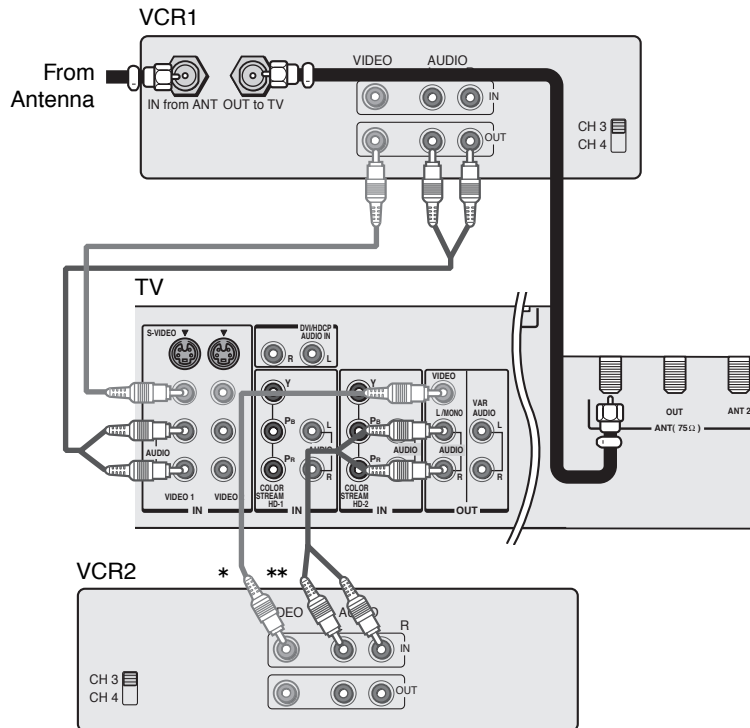

Note:

If you have VCRs with S-video, use S-video cables instead of standard video cables. Do not connect both a standard video cable and an S-video cable to VIDEO 1 (or VIDEO 2) at the same time, or the picture performance will be unacceptable.

Do not connect the same VCR to the output and input terminals on the TV at the same time.

To dub or edit, VCR 2 must select Line IN, and the TV must select VIDEO 1.

* The Video OUT terminals does not output the POP picture.

** The Audio OUT terminals can output the sound of either the Main or POP picture (see "Selecting the Audio OUT sound" on page 58).

The unauthorized recording, use, distribution, or revision of television programs, videotapes, DVDs, and other materials is prohibited under the Copyright Laws of the United States and other countries, and may subject you to civil and criminal liability.

Connecting a camcorder

This connection allows you to watch video materials recorded on a camcorder.

You will need:

- one set of standard A/V cables

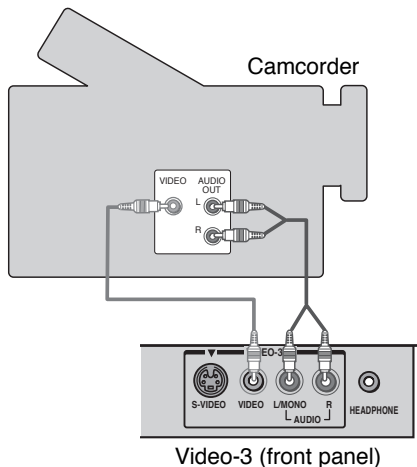

Note:

If you have a camcorder with S-video, use an S-video cable instead of a standard video cable. Do not connect both a standard video cable and an S-video cable at the same time, or the picture performance will be unacceptable.

Connecting a device to the DVI/HDCP

Your TV's DVI/HDCP* IN terminal is designed to accept HDCP program material in digital form from EIA/CEA-861-compliant** consumer electronic devices, such as a set-top box or DVD player equipped with a DVI-D digital single-link OUT terminal.†

The DVI/HDCP IN terminal is designed for best performance with 1080i high-definition video signals, but also will accept and display 480p, 720p, and 480i picture signals.

Note: *This TV is not intended for connection to and should not be used with a PC (personal computer).*

You will need:

- one DVI-D digital single-link cable

You will need:

Note: *For proper operation, the DVI-D cable length should not exceed 3m (9.8 ft). The recommended length is 2m (6.6 ft).*

- one pair of standard audio cables

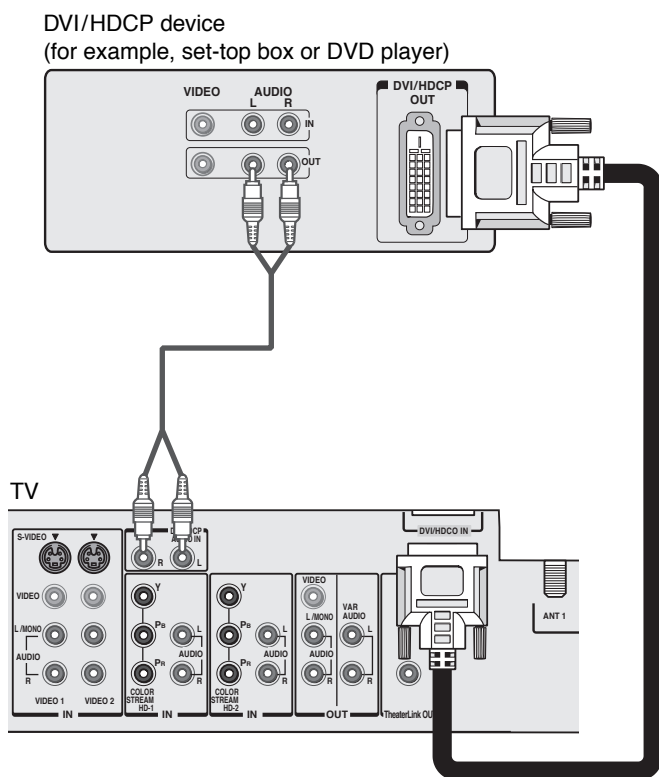

* DVI/HDCP = Digital Visual Interface/ High-bandwidth Digital Content Protection.

** EIA/CEA-861 compliance covers the transmission of uncompressed digital video with high-bandwidth digital content protection, which is being standardized for future reception of high-definition video signals.

† Consult your consumer electronics dealer for availability.

Notes

- **Make sure the DVI cable is fastened securely to the TV and DVI device.**

If the cable is not fastened securely on both ends, the TV may suffer from picture noise ("snow") or have no picture at all.

- *To ensure that the DVI/HDCP device is reset properly, it is recommended that you follow these procedures:*

- When turning on your electronic devices, **turn on the TV first**, and then the DVI/HDCP device.*
- When turning off your electronic devices, **turn off the DVI/HDCP device first**, and then the TV.*

Connecting a device to the TheaterLink

The TheaterLink allows you to remotely operate (through the TV) most infrared-controlled devices* (such as a Toshiba infrared-controlled VCR or DVD player) enclosed within an entertainment center or similar cabinet. Without the TheaterLink, the device typically would need to be visible to operate it remotely.

You can use the TV's remote control (programmed to operate the device; see pages 18–24) or the device's remote control. Point the remote control at the front of the TV and press the button for the desired function. The signal passes from the remote control through the TV to the device via the TheaterLink cable (included with your TV).

To connect, align the TheaterLink cable's infrared "eye" with the device's infrared sensor and attach it using double-sided mounting tape (included with the cable in the accessory pack). Plug the other end of the TheaterLink cable into the TV's TheaterLink OUT terminal.

You will need:

- one TheaterLink cable (included)
- one piece of double-sided mounting tape (included)

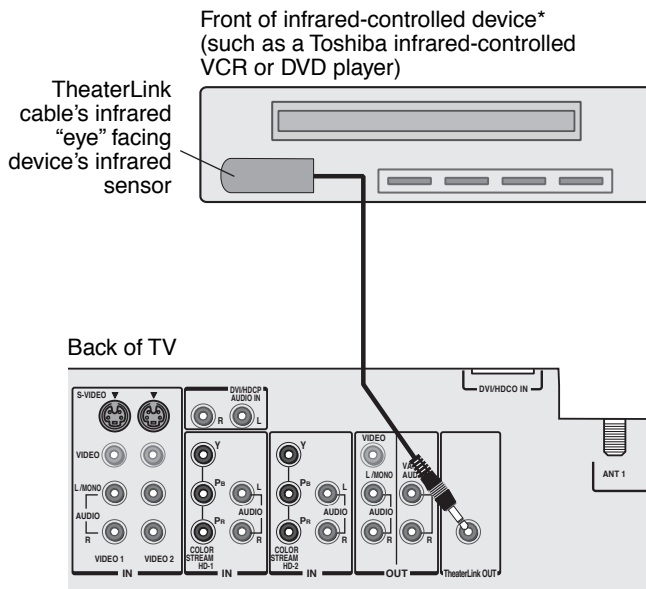

With this connection, point the Toshiba TV remote control at the front of the TV to operate both the TV and the infrared-controlled device. (You also can point the device's remote control at the TV to operate the device, but you also will need to use the TV's remote control to operate the TV.)

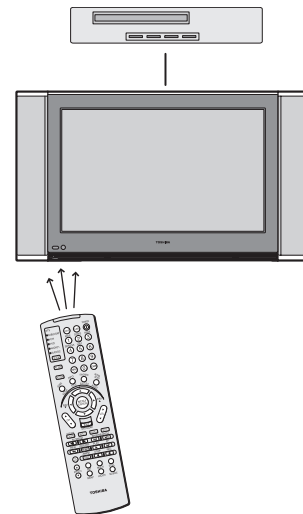

*The TheaterLink OUT function has been verified for use with Toshiba infrared-controlled devices. Due to the wide variation in remote control operation among manufacturers, these functions may or may not operate with other brands.

Connecting an audio system

This connection allows you to hear the TV sound through external speakers connected to an audio amplifier.

To control the audio through the amplifier, turn on the TV and the amplifier, set the volume of both to a moderate level, and turn off the TV's built-in speakers (see "Turning off the built-in speakers" on page 58).

You will need:

- one pair of standard audio cables

Note:

If the volume of either the TV or the amplifier is set to 0 (or OFF), you will not hear any sound.

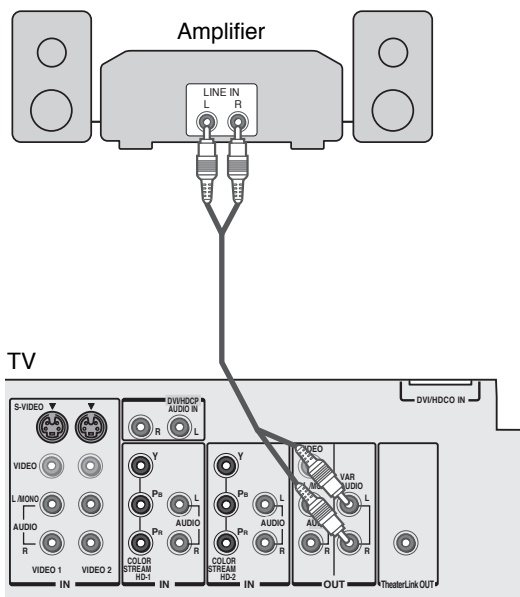

Using the remote control

Preparing the remote control for use

Your Toshiba TV remote control has one dedicated TV mode and five universal modes: VCR, Cable/SAT, DVD, Audio1, and Audio2. The target devices and default devices being programmed for each mode are as follows:

Target device/Mode mapping

Mode	Device
TV	Toshiba TV
CABLE/SAT	Universal Cable, Satellite
VCR	Universal VCR, DVD, LD, Cassette
DVD	Universal DVD, VCR, LD, Cassette
AUDIO1	Universal Audio: Amp., Tuner, Misc.Audio, CD/MD
AUDIO2	Universal Audio: CD/MD, Amp., Tuner, Misc.Audio

Default device codes

Mode	Default device
TV	Toshiba TV
CABLE/SAT	Toshiba Satellite receiver
VCR	Toshiba VCR
DVD	Toshiba DVD
AUDIO1	Pioneer Audio receiver
AUDIO2	Pioneer LD

Repeatedly press MODE to cycle among the modes. If you own different brands of audio/video devices, you must first program your remote control (see “Programming the remote control for use with your audio/video devices” on page 21).

Installing the remote control batteries

To install the batteries:

1. Slide the battery cover off the back of the remote control.

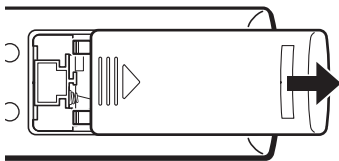

2. Install two “AA” size alkaline batteries. Match the + and – signs on the batteries to the signs on the battery compartment.

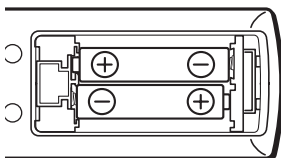

3. Slide the battery cover back on to the remote control until the lock snaps.

Note:

Your TV's remote control may not operate certain features on your VCR, cable TV converter, or other electronic device.

Refer to the owner's manuals for your other devices to determine their available features. If your TV's remote control does not operate a specific feature on a device, use the remote control that came with the device.

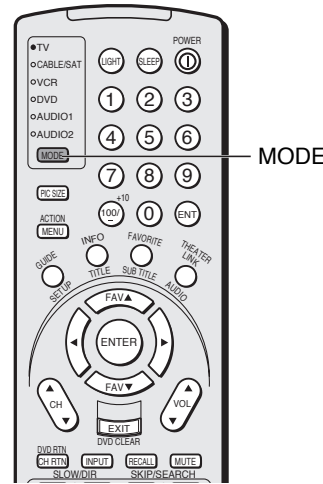

Caution:

- Dispose of batteries in a designated disposal area. Do not throw batteries into a fire.
- Do not mix battery types or combine used batteries with new ones.
- If the remote control does not operate correctly, or if the operating range becomes reduced, replace both batteries with new ones.
- If the batteries are dead or if you will not use the remote control for a long time, remove the batteries to prevent battery acid from leaking into the battery compartment.

Remote Control functional key chart

Key Label	Toshiba TV (TV)	Cable (CBL/SAT)	Satellite (CBL/SAT)	VCR	DVD/LD	Receiver (AUDIO)	CD/MD (AUDIO)	Cassette (VCR)
LIGHT	Lights the remote key, and toggles between enabled and disabled Illumination mode.							
SLEEP	Sleep timer	---	---	---	---	---	---	---
POWER	Power	Power	Power	Power	Power	Power	Power	Power
1	Digit 1	Digit 1	Digit 1	Digit 1	Digit 1	AV input 1	Digit 1	Digit 1
2	Digit 2	Digit 2	Digit 2	Digit 2	Digit 2	AV input 2	Digit 2	Digit 2
3	Digit 3	Digit 3	Digit 3	Digit 3	Digit 3	AV input 3	Digit 3	Digit 3
4	Digit 4	Digit 4	Digit 4	Digit 4	Digit 4	AV input 4	Digit 4	Digit 4
5	Digit 5	Digit 5	Digit 5	Digit 5	Digit 5	CD	Digit 5	Digit 5
6	Digit 6	Digit 6	Digit 6	Digit 6	Digit 6	Tuner	Digit 6	Digit 6
MODE	Remote control device mode selection							
PIC SIZE	Selects the image shape.	← TV	← TV	← TV	← TV	← TV	← TV	← TV
7	Digit 7	Digit 7	Digit 7	Digit 7	Digit 7	Phono	Digit 7	Digit 7
8	Digit 8	Digit 8	Digit 8	Digit 8	Digit 8	Cassette	Digit 8	Digit 8
9	Digit 9	Digit 9	Digit 9	Digit 9	Digit 9	Aux	Digit 9	Digit 9
ACTION	---	---	Action, Menu	---	Menu	---	---	---
100/-	100	---	100/-	---	+10	---	---	---
0	Digit 0	Digit 0	Digit 0	Digit 0	Digit 0	Digit 0	Digit 0	Digit 0
ENT (H Enter)	---	CH Enter	---	---	---	---	---	---
GUIDE/SETUP	---	---	Guide	---	DVD setup	---	---	---
INFO/TITLE	---	---	INFO	---	TITLE= Top menu	---	---	---
FAVORITE/ SUBTITLE	Favorites	---	Favorites	---	Subtitle	---	---	---
THEATERLINK/ AUDIO	TheaterLink	---	---	---	Audio	---	---	---
MENU/ ACTION	Menu	---	Action Menu	---	Menu	---	---	---
▲▼/FAV ▲▼	Menu select/ FAV ▲▼	---	Menu select	---	Menu select	---	---	---
◀▶	Menu select	---	Menu select	---	Menu select	---	---	---
ENTER	Enter	---	Select	---	Enter	---	---	---
VOL ▲▼	Volume up/down*	Volume up/down*	Volume up/down*	Volume up/down*	Volume up/down*	Volume up/down*	Volume up/down*	Volume up/down*
EXIT/ DVD CLEAR	Exit	---	Exit	---	DVD clear	---	---	---
CH ▲▼	Channel up/down	Channel up/down	Channel up/down	Channel up/down	---	Channel up/down	---	---
INPUT	TV/Video select	← TV	← TV	VCR input	← TV	Input	← TV	← TV
MUTE	Sound mute*	Sound mute*	Sound mute*	Sound mute*	Sound mute*	Sound mute*	Sound mute*	Sound mute*
RECALL	On-screen display	On-screen display	On-screen display	On-screen display	On-screen display	---	---	---
CH RTN/ DVD RTN	Previous channel	Previous channel	Previous channel	---	DVD return	---	---	---
SLOW/ DIR	▶ ◀	---	---	Slow FWD ---	Slow FWD Slow REV	---	---	---
SKIP/ SEARCH	▶ ◀	---	---	---	Skip FWD Skip REV	---	Skip FWD Skip REV	---
REW	VCR →	VCR →	VCR →	Rewind	Rewind	---	Rewind	Rewind
PAUSE/STEP	VCR →	VCR →	VCR →	Pause	Pause	---	Pause	Pause
PLAY	VCR →	VCR →	VCR →	Play	Play	---	Play	Play
FF	VCR →	VCR →	VCR →	Fast FWD	Fast FWD	---	Fast FWD	Fast FWD

Key Label	Toshiba TV (TV)	Cable (CBL/SAT)	Satellite (CBL/SAT)	VCR	DVD/LD	Receiver (AUDIO)	CD/MD (AUDIO)	Cassette (VCR)
TV/VCR	VCR →	---	TV/SAT	TV/VCR	---	---	---	Reverse
AM/FM DISC	---	---	---	---	Disc shift	AM/FM	Disc shift	Deck side A/B switch
STOP	VCR →	VCR →	VCR →	Stop	Stop	---	Stop	Stop
REC**	VCR →	VCR →	VCR →	Record**	---	---	Record**	Record**
PIP CH ▲▼	POP channel up/down	← TV	← TV	← TV	← TV	← TV	← TV	← TV
SPLIT	POP Split	← TV	← TV	← TV	← TV	← TV	← TV	← TV
POP DIRECT CH	POP Direct ch	← TV	← TV	← TV	← TV	← TV	← TV	← TV
FREEZE	POP Freeze	← TV	← TV	← TV	← TV	← TV	← TV	← TV
SWAP	POP Swap	← TV	← TV	← TV	← TV	← TV	← TV	← TV
CH SCAN	POP Ch scan	← TV	← TV	← TV	← TV	← TV	← TV	← TV
SOURCE	POP Source	← TV	← TV	← TV	← TV	← TV	← TV	← TV

Notes:

- “---” will send nothing.
- “← TV” will jump to TV.
- “→ VCR” will jump to last active VCR or DVD. Active VCR/DVD is defined as the mode that remains for a minimum of 5 seconds, or if a key is pressed in that mode.
- * The VOLUME and MUTE will jump to “TV” by default. When the volume is unlocked, all the devices will have their own volume. The AUDIO1/2 (Receiver, CD) modes will have their own volume even if Volume Lock is on TV, CABLE/SAT, VCR, or DVD. See “Using the Volume Lock feature” on page 22.
- ** Press the REC button twice within 5 seconds to record each audio/video source.

Programming the remote control for use with your audio/video devices

Device code setup

1. Refer to the Device code table on pages 23–24 to find the code for the brand of your device.
If more than one number is listed, try each one separately until you find the one that works.
2. Press MODE until the Mode indicator of the device (CABLE/SAT, VCR, DVD, AUDIO1, AUDIO2) lights up.
3. While holding down the RECALL button, press the Channel Number buttons to enter the four-digit code of your brand of device. If a valid code is entered, the mode indicator will blink twice. If an invalid code is entered, the mode indicator will blink one long blink.
4. Point the remote control at the device and press POWER to test the code.
If the device turns on, you have entered the correct code.
If the device does not respond to the remote control, you may have entered the wrong code. Repeat steps 3 and 4 using another code.
5. Press MODE to select the TV mode to control the TV.

Searching and sampling the code of a device (8500)

If you do not know the device code for a particular target unit, you can cycle the remote control through the available codes for that device mode and sample the functions to find the code that properly operates the target device. The keys available to be sampled, provided they are applicable to that mode, are POWER, 1, VOL ▲, CH ▲, and PLAY. Invalid keys will be ignored while in program mode.

To cycle through each available device code and sample its functions:

1. Press MODE to select the mode you want to set up.
2. While holding down the RECALL button, press 8 –5 –0 –0. The remote control will enter program mode.
3. Point the remote control at the target device and press POWER (or other function buttons that are available to be sampled).
4. If the device responds to the remote control:
Press RECALL to store the device code.
The mode indicator will blink twice and the remote control will exit the program mode.
If the device does not respond to the remote control:
Press ▲, and then press POWER.
Repeat this step until the device responds to the remote control, and then press RECALL.

Note: When a search cycle is completed, the mode indicator will blink three times. The remote control will begin to cycle through the available codes again. If no key is pressed within 10 seconds while programming, the remote control will exit the program mode and return to the previous code.

Note:

- Every time you replace the batteries, you must reprogram the remote control.
- Some newer VCRs are capable of working on either of two remote codes. These VCRs have a switch labeled “VCR1/VCR2.”

If your VCR has this kind of switch and does not respond to any of the codes for your VCR brand, set the switch to the other position (VCR1 or VCR2) and reprogram the remote control

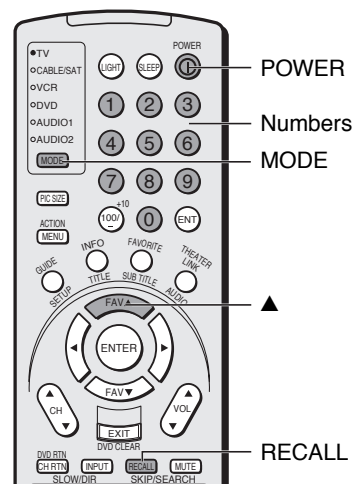

Using the volume lock feature (8000)

For the TV, CABLE/SAT, VCR, and DVD modes, the volume controls (VOL ▲▼ and MUTE) can be programmed (locked) to the selected device mode. This feature does not apply to the AUDIO1/2 modes.

For example, to lock the volume controls to always jump to the CABLE/SAT mode:

1. Repeatedly press MODE to select the CABLE/SAT mode.
 2. While holding down the RECALL button, press 8 -0 -0 -0.
 3. Press VOL ▲.
- The Mode indicator will blink two times (locked).

The following table describes in more detail the Volume Lock implementation.

Volume Locked to	TV	CBL/SAT	VCR	DVD	AUD1	AUD2
TV (default)	TV	TV	TV	TV	AUD1	AUD2
CBL/SAT	CBL/SAT	CBL/SAT	CBL/SAT	CBL/SAT	AUD1	AUD2
VCR	VCR	VCR	VCR	VCR	AUD1	AUD2
DVD	DVD	DVD	DVD	DVD	AUD1	AUD2
AUD1	AUD1	AUD1	AUD1	AUD1	AUD1	AUD1
AUD2	AUD2	AUD2	AUD2	AUD2	AUD2	AUD2

To reset the volume controls to the original device code:

1. While holding down the RECALL button, press 8 -0 -0 -0.
 2. Press VOL ▼.
- The Mode indicator will blink four times (unlocked).

Operational feature reset (8900)

This feature clears all setup features not related to “Device code set up” and resets the Volume Lock to “TV.”

To reset the features:

- While holding down the RECALL button, press 8 -9 -0 -0.
The Mode indicator will blink two times, and then pause and blink two more times.

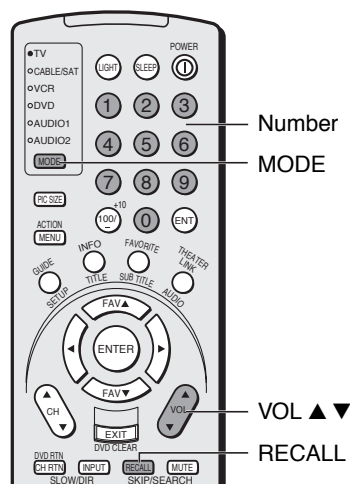

Device code table

VCR setup codes		Cable box setup codes	
Brand	Code	Brand	Code
ADMIRAL	0135	PHILCO	0131, 0124, 0127, 0123, 0126, 0120, 0143
AIWA	0127, 0132, 0181	PHILIPS	0131, 0123, 0124, 0173
AKAI	0129, 0114, 0115, 0116	PIONEER	0123
AUDIO DYNAMIC	0139, 0111	PROSCAN	0145, 0100, 0123, 0124, 0131, 0146, 0101, 0102, 0133, 0174
BELL&HOWELL	0105, 0113	QUASAR	0121, 0122, 0123, 0124
BROKSONIC	0120, 0126, 0180	RADIO SHACK	0133, 0124, 0105, 0136, 0109, 0140, 0127
CANON	0123, 0125	RCA	0133, 0145, 0100, 0123, 0124, 0131, 0146, 0101, 0102, 0170, 0172, 0174, 0176, 0183
CCE	0143	REALISTIC	0124, 0105, 0136, 0109, 0140, 0127
CITIZEN	0106	SAMSUNG	0137, 0102, 0104, 0133
CRAIG	0105, 0129, 0106	SAMTRON	0163
CURTIS MATHES	0145, 0124, 0127	SANSUI	0139, 0126, 0120, 0152
DAEWOO	0143, 0101, 0124, 0175	SANYO	0105, 0109, 0113
DBX	0139, 0110, 0111	SCOTT	0101, 0102, 0104, 0109, 0138, 0140, 0147, 0148, 0126, 0120
DIMENSIA	0145	SEARS	0105, 0106, 0107, 0108, 0100
EMERSON	0143, 0126, 0119, 0103, 0125, 0142, 0120, 0118	SHARP	0135, 0136, 0167, 0162
FISHER	0105, 0108, 0109, 0107, 0113, 0165	SHINTOM	0117
FUNAI	0127, 0126, 0120, 0134	SIGNATURE 2000	0127, 0135
GE	0133, 0145, 0124	SINGER	0117
GO VIDEO	0137, 0151, 0163, 0149, 0150, 0182	SONY	0128, 0129, 0130, 0153, 0154, 0155
GOLDSTAR	0106	SV2000	0127
GRADIENTE	0170, 0171, 0168, 0134, 0156	SYLVANIA	0131, 0123, 0124, 0127, 0178
HITACHI	0123, 0145, 0100, 0127, 0168	SYMPHONIC	0127, 0168, 0177
INSTANT REPLAY	0124, 0123	TASHIRO	0106
JENSEN	0139	TATUNG	0139, 0110, 0111
JVC	0139, 0110, 0111, 0134, 0157, 0158, 0184, 0185	TEAC	0139, 0110, 0127, 0111
KENWOOD	0139, 0110, 0106, 0111	TECHNICS	0121, 0122, 0123, 0124
LG	0159	TEKNICA	0124, 0127, 0112
LXI	0127, 0106, 0100, 0107, 0108, 0105, 0109	THOMSON	0179, 0183
MAGNAVOX	0131, 0123, 0124, 0173	TOSHIBA	0101, 0146, 0166, 0160
MARANTZ	0139, 0110, 0111	VECTOR RESEARCH	0111
MARTA	0106	WARDS	0135, 0136, 0109, 0144, 0106
MEMOREX	0124, 0109	YAMAHA	0105, 0139, 0110, 0111
MGA	0138, 0140, 0147, 0148, 0141, 0142	ZENITH	0144, 0106, 0169, 0180
MINOLTA	0100, 0145		
MITSUBISHI	0138, 0140, 0147, 0148, 0141, 0142, 0161, 0164		
MULTITECH	0147, 0127, 0104		
NEC	0139, 0110, 0111, 0134		
OLYMPIC	0124, 0123		
OPTIMUS	0128, 0121, 0135, 0106		
ORION	0126, 0120, 0132		
PANASONIC	0123, 0124, 0121, 0122		
PENNEY	0124, 0100, 0145, 0105, 0139, 0110, 0111		
PENTAX	0100, 0111, 0145		
		ABC	1124
		ARCHER	1132, 1125
		CABLEVIEW	1105, 1132
		CITIZEN	1122, 1105
		CURTIS	1112, 1113
		DIAMOND	1124, 1132, 1125
		EAGLE	1129
		EASTERN	1134
		GCBRAND	1132, 1105
		GEMINI	1122, 1143
		G.I./JERROLD	1119, 1124, 1125, 1126, 1127, 1120, 1121, 1122, 1111, 1123, 1152
		HAMLIN	1140, 1141, 1142, 1145, 1118, 1112
		HITACHI	1103, 1124
		MACOM	1103, 1104, 1105, 1108
		MAGNAVOX	1133
		MEMOREX	1130
		MOVIETIME	1132, 1105
		OAK	1139, 1137, 1102
		PANASONIC	1109, 1110, 1114, 1151, 1153
		PHILIPS	1128, 1129, 1130, 1106, 1107, 1150, 1131
		PIONEER	1101, 1116
		PULSAR	1105, 1132
		PUSER	1132
		RCA	1115
		REALISTIC	1132
		REGAL	1112, 1118, 1140, 1141, 1142, 1145, 1149
		REGENCY	1134
		REMBRANT	1137, 1132, 1105, 1138
		SAMSUNG	1105
		S.A.	1111, 1112, 1113
		SLMARK	1105, 1101
		SPRUCER	1105, 1110
		STARGATE	1132, 1105
		TELECAPTION	1148
		TELEVIEW	1101, 1105
		TEXSCAN	1144
		TOCOM	1135, 1136, 1147
		TOSHIBA	1104, 1146
		UNIKA	1132, 1125
		UNIVERSAL	1122, 1132
		VIDEOWAY	1106
		VIEWSTAR	1129, 1130
		ZENITH	1117, 1100
		ZENITH/DRAKE	
		SATELLITE	1100

Introduction

Connecting your TV

Using the Remote Control

Setting up your TV

Using the TV's Features

Appendix

Index

Device code table

CD Player setup codes

Brand	Code
ADMIRAL	6126
AIWA	6133, 6135
CARVER	6129
DENON	6142, 6151
EMERSON	6139
FISHER	6105, 6106
GARRARD	6117
HARMAN KARDON	6120, 6121, 6123, 6119
HITACHI	6107
JENSEN	6134
JVC	6140, 6141, 6145, 6148, 6151
KENWOOD	6100, 6101, 6111, 6145
LXI	6136
MAGNAVOX	6129, 6132
MARANTZ	6129
MCINTOSH	6121
NAKAMICHI	6110
ONKYO	6114, 6115
OPTIMUS	6108, 6118, 6120, 6122
PANASONIC	6124, 6125, 6127, 6150
PHILIPS	6129, 6130, 6149
PIONEER	6108
QUASAR	6125, 6127, 6124
RCA	6147, 6137, 6138, 6131, 6152
SANSUI	6110, 6146, 6113
SANYO	6105
SCOTT	6110, 6146
SHARP	6142, 6143
SHERWOOD	6120
SONY	6128
SOUNDE-SIGH	6144
TEAC	6112, 6116, 6118
TECHNICS	6127, 6124, 6125
VICTOR	6140, 6141, 6145
YAMAHA	6102, 6103, 6104

Receiver setup codes

Brand	Code
ADMIRAL	4120
AIWA	4125, 4126, 4146
DENON	4134, 4135, 4136, 4143
FISHER	4104
GARRARD	4113
HARMAN KARDON	4115, 4123, 4145
JENSEN	4129
JVC	4132, 4133, 4140, 4144
KENWOOD	4100, 4108, 4141, 4142, 4147
MAGNAVOX	4127, 4128
MARANTZ	4124
MCINTOSH	4116
MITSUBISHI	4148
NAKAMICHI	4106, 4117
ONKYO	4109, 4114
OPTIMUS	4103, 4127, 4131, 4130
PANASONIC	4119, 4118, 4121
PHILIPS	4123
PIONEER	4105, 4107, 4150

QUASAR	4119, 4118, 4121
RCA	4103, 4105, 4127, 4131, 4130, 4149
SANSUI	4103, 4111, 4139
SHARP	4134, 4137
SONY	4122
SOUNDE-SIGH	4138
TEAC	4112, 4113, 4111, 4110
TECHNICS	4121, 4118, 4119
VICTOR	4132, 4133
YAMAHA	4101, 4102

Cassette Player setup codes

Brand	Code
AIWA	7123, 7124, 7125
DENON	7131
FISHER	7103
JENSEN	7114
JVC	7129, 7130, 7132, 7133
KENWOOD	7100, 7107
MARANTZ	7102
NAKAMICHI	7105
ONKYO	7108, 7109, 7113
PANASONIC	7116, 7118
PHILIPS	7122, 7121
PIONEER	7104, 7106
RCA	7126, 7127, 7128, 7134, 7135
SANSUI	7105, 7110, 7112
SHARP	7131
SONY	7119, 7120
TEAC	7110, 7111, 7115
TECHNICS	7116, 7118, 7117
YAMAHA	7101, 7102

Laser Disc setup codes

Brand	Code
DENON	5114
HITACHI	5100
KENWOOD	5102, 5103
MAGNAVOX	5101
MARANTZ	5114
MITSUBISHI	5114, 5118, 5119
NEC	5114
PANASONIC	5104, 5105, 5106, 5115
PHILIPS	5111
PIONEER	5114
PROSCAN	5114
QUASAR	5104, 5105, 5106, 5115
RCA	5114
SAMSUNG	5112
SANYO	5114, 5117
SHARP	5113, 5116
SONY	5107, 5108, 5109, 5110
TEAC	5114
TOSHIBA	5114
YAMAHA	5101

DVD setup codes

Brand	Code
AIWA	3123
APEX	3120
DENON	3100, 3117
FERGUSON	3101
HITACHI	3111
JVC	3109
KENWOOD	3115, 3129
KONKA	3119
MITSUBISHI	3105
NORDMENDE	3101
ONKYO	3121
ORITRON	3124
PANASONIC	3100
PHILIPS	3103, 3116
PIONEER	3102
RAITE	3113
RCA	3101, 3106
SABA	3101
SAMPO	3114
SAMSUNG	3110
SHARP	3108
SILVANIA	3132, 3118
SMC	3125
SONY	3104, 3126, 3127, 3128
TECHNICS	3100
THOMSON	3101
TOSHIBA	3103
WAVE	3122
YAMAHA	3100, 3130
ZENITH	3107, 3112
VIALTA	3131
FUNAI	3132, 3118

Satellite Receiver setup codes

Brand	Code
DISH NETWORK (EchoStar)	2105, 2115, 2116, 2117
ECHOSTAR	2105
EXPRESS VU	2105, 2115
G.E.	2106
G.I. (GENERAL INSTRUMENT)	2108
GRADIENTE	2114
HITACHI	2103, 2111, 2112
HNS (Hughes)	2103
MAGNAVOX	2101, 2102
PANASONIC	2104
PHILIPS	2101, 2102, 2118
PRIMESTAR	2108
PROSCAN	2106, 2109, 2110, 2113
RCA	2106, 2109, 2110, 2113
SONY	2107
STAR CHOICE	2103, 2108
TOSHIBA	2100, 2103, 2119, 2120, 2121
UNIDEN	2101, 2102

Learning about the remote control

The buttons used for operating the TV only are described here. For a complete list of the remote control's functions, see the "Remote Control functional key chart" on pages 19–20.

POWER turns the TV on and off

SLEEP allows access to the automatic TV shut-off function (page 53)

LIGHT The first press of the LIGHT button lights the keypad and turns on the Illumination mode. With the Illumination mode on, pressing any other key lights the keypad for 5 seconds (10 seconds if you're in programming mode). Subsequent presses of the LIGHT button toggle between turning the Illumination mode on and off.

Channel Numbers (0-9, 100) allow direct access to channels (page 30)

MODE cycles through the six device modes: TV, CABLE/SAT, VCR, DVD, AUDIO1, and AUDIO2. The mode indicator light will remain lit for a few seconds (page 21).

PIC SIZE cycles through the five picture sizes: Natural, Theater Wide 1, 2, 3, and Full (page 34)

FAVORITE allows access to the favorite channel search function (page 41)

MENU allows access to on-screen programming menus (page 26)

ENTER sets programming menu information (page 26)

▲▼◀▶ select or adjust programming menus (page 26)

FAV ▲▼ cycles through favorite channels (page 32)

CH ▲▼ cycles through programmed channels (page 29)

VOL ▲▼ adjusts the volume level

EXIT exits the programming menus (page 26)

INPUT selects the video input source (page 50)

MUTE mutes the sound (page 54)

RECALL displays on-screen information (page 60)

CH RTN returns to the last viewed channels (page 31)

POP CH ▲▼ selects the POP (picture-out-picture) channel (page 38)

SPLIT turns the POP feature on and off (page 38)

CH SCAN allows access to the programmed channel search function (page 40)

FREEZE freezes the POP picture (page 39)

SWAP switches the main and POP pictures (page 39)

POP DIRECT CH allows direct access to POP channels (page 38)

SOURCE selects the POP picture source (page 38)

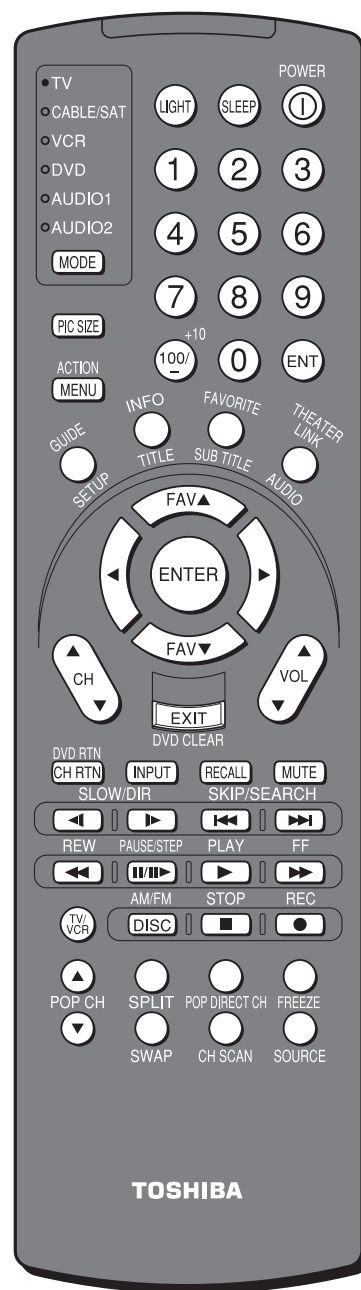

Note:

The error message "Not Available" will appear if you press a key for a function that is not available.

Setting up your TV

Learning about the menu system

After you have installed the batteries and programmed the remote control, you will need to set some preferences on the TV using the menu system. You can access the menu using the buttons on your TV or remote control.

1. Press MENU to display the menu system.
2. Press ◀ or ▶ to select a menu.
3. Press ▲ or ▼ to select an item.
4. Press ◀ or ▶ to select or adjust a setting.

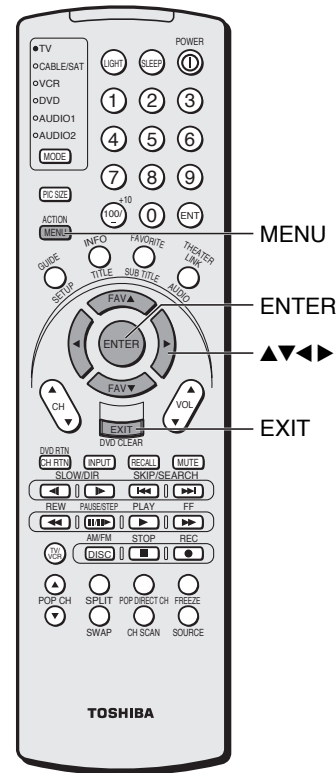
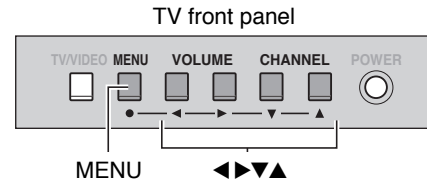
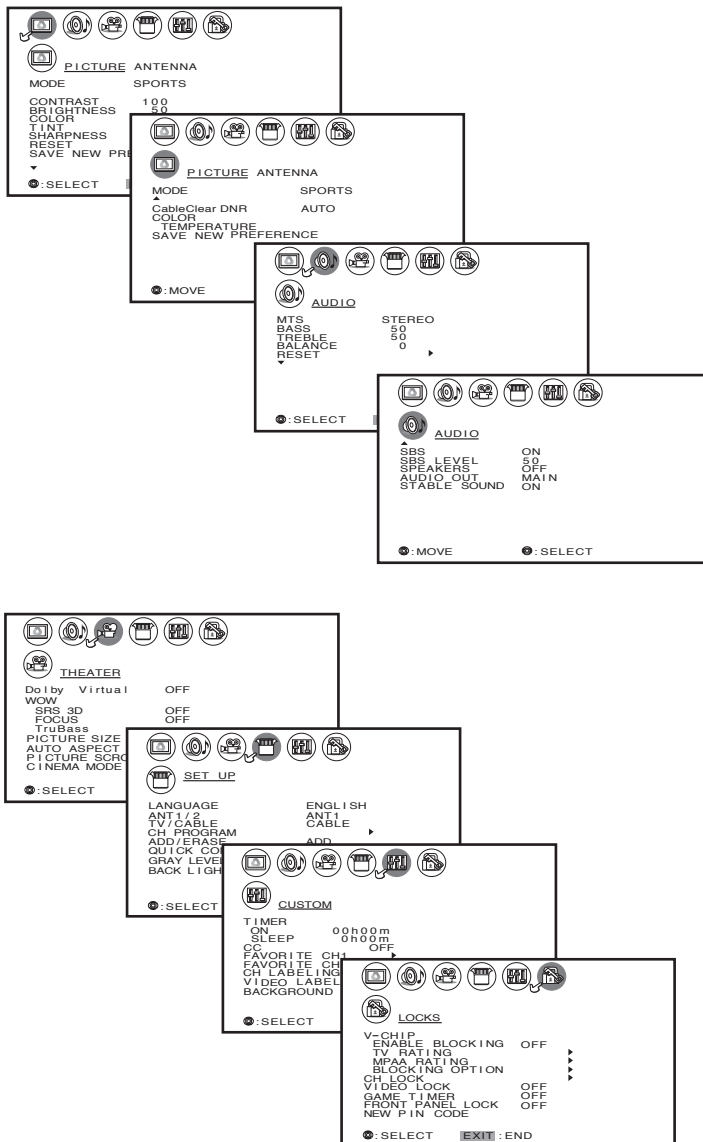

Note:
You can change the background of the menu.
See page 51 for details.

- Press ENTER to activate the function settings in the menus.
- If you do not make a selection within 15 seconds, the main menus close automatically; the other menus close automatically within 6 seconds.
- To close an on-screen menu instantly, press EXIT.

Using the Quick Connect Guide

The Quick Connect Guide automatically starts the first time the TV is turned on. This feature provides on-screen instructions to guide you through initial setup of your TV.

To manually start the Quick Connect Guide and change the current settings.

1. Press MENU, and then press ◀ or ▶ until the SET UP menu appears.
2. Press ▲ or ▼ to highlight “QUICK CONNECT GUIDE.”

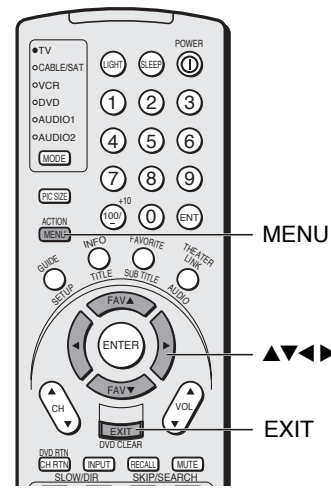
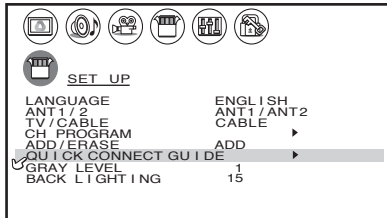

3. Press ◀ or ▶ to enter the Quick Connect Guide mode. Advance through the setup according to the guide displayed on-screen.
 - Press ◀ or ▶ to make a selection.
 - Press MENU to continue to the next screen.

The Quick Connect Guide will guide you through the following items.

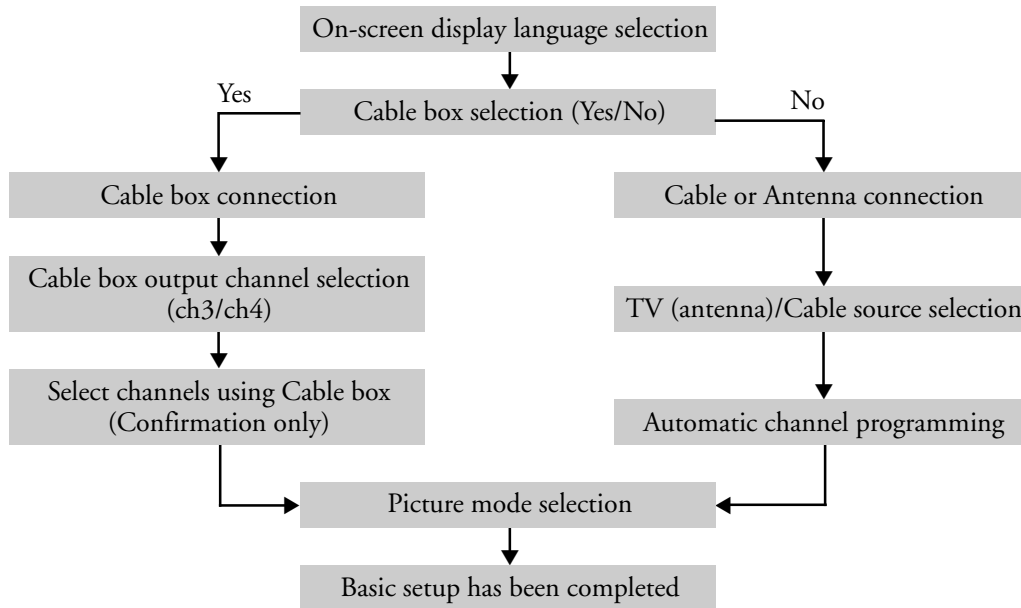

To stop the Quick Connect Guide:
Press EXIT or turn off the TV.

Changing the on-screen display language

You can choose from three different languages (English, French and Spanish) for the on-screen display of adjustment menus and messages.

To select a language:

1. Press MENU, and then press ◀ or ▶ until the SET UP menu appears.
2. Press ▲ or ▼ to highlight LANGUAGE.

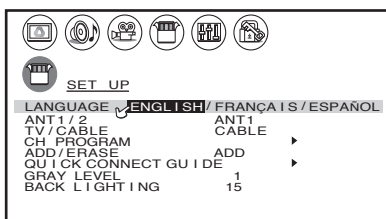

3. Press ◀ or ▶ to highlight your desired language.

Selecting the antenna input

You can connect to two different antenna input sources (ANT 1 or ANT 2).

To select the antenna input using the INPUT or TV/VIDEO button:

Press INPUT on the remote control or TV/VIDEO on the TV (see illustrations below). The current signal source displays in purple.

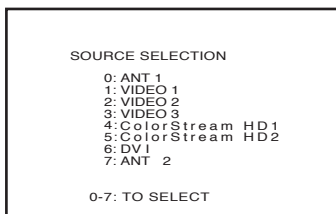

Pressing INPUT on the remote control displays the current signal source (press INPUT again or 0-7 to change)

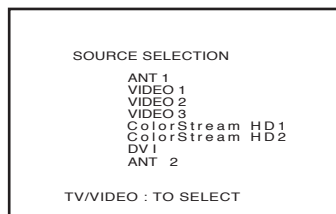

Pressing TV/VIDEO on the TV changes the current signal source

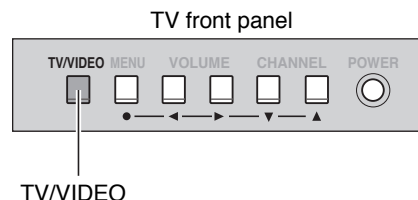
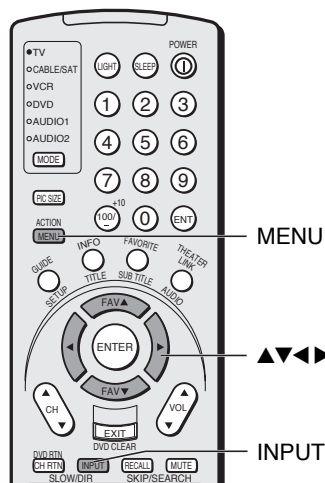
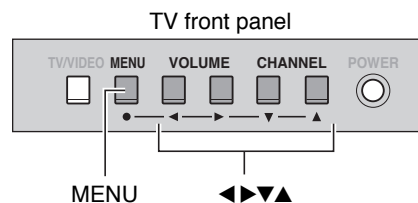

To select the antenna input using the menu system:

1. Press MENU, and then press ◀ or ▶ to highlight the SET UP menu.
2. Press ▲ or ▼ to highlight ANT 1/2.

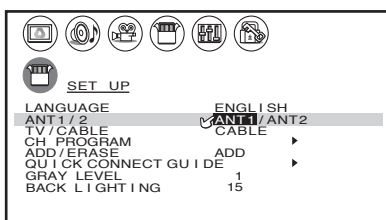

3. Press ◀ or ▶ to highlight either ANT 1 or ANT 2, depending on the antenna terminal you wish to use.

Adding channels to the TV's memory

When you press Channel ▲ or ▼, your TV will stop only on the channels you program into the TV's channel memory.

Follow the steps below and on the next page to program all active channels into the TV's memory.

Programming channels automatically

Your TV can automatically detect all active channels in your area and store them into its memory. After the channels are programmed automatically, you can manually add or erase individual channels (see page 30).

To program channels automatically:

1. Press MENU, and then press ◀ or ▶ until the SET UP menu appears.
2. Press ▲ or ▼ until TV/CABLE is highlighted.
3. Press ◀ or ▶ to highlight either TV or CABLE, depending on which you use. If you use an antenna, highlight TV; if you use cable, highlight CABLE.

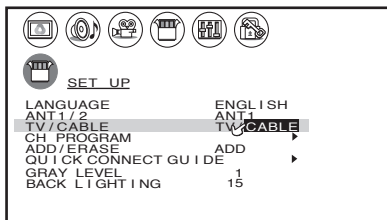

4. Press ▼ to select CH PROGRAM.

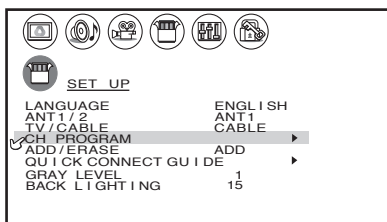

5. Press ◀ or ▶ to start channel programming. The TV will automatically cycle through all the TV or Cable channels (depending on which you selected), and store all active channels in the channel memory.

While the TV is cycling through the channels, the message “Programming Now—Please Wait” appears.

6. When channel programming is complete, the message “Completed” appears.
7. Press Channel ▲ or ▼ to view the programmed channels.

Note:

To tune the TV to a channel not programmed in the channel memory, you must use the Channel Number buttons on the remote control.

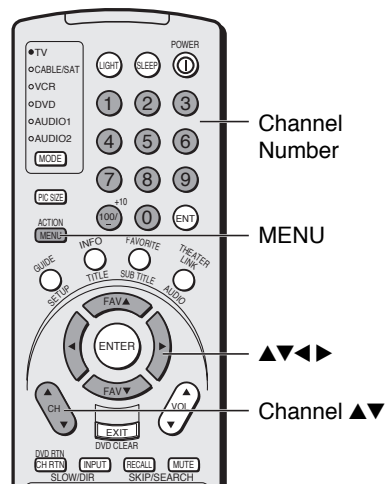

Adding and erasing channels manually

After you have automatically programmed the active channels into the TV's channel memory, you can manually add or erase specific channels.

To add or erase channels:

1. Select the channel you want to add or erase. If you are adding a channel, you must select the channel using the Channel Number buttons.
2. Press MENU, and then press ◀ or ▶ until the SET UP menu appears.
3. Press ▲ or ▼ to highlight ADD/ERASE.

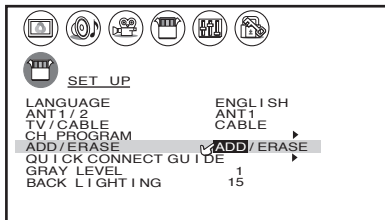

4. Press ◀ or ▶ to select ADD or ERASE, depending on the function you want to perform.
5. Repeat steps 1–4 for other channels you want to add or erase.

Changing channels

To change to the next programmed channel:

Press Channel ▲ or ▼ on the TV or remote control.

To change to a specific channel (programmed or unprogrammed):

Press the Channel Number buttons (0–9 and 100).

For channels 100 and higher, press the 100 button, and then the next two numbers. For example, to select channel 125, press 100, 2, 5.

Changing channels using SpeedSurf

To change to a specific programmed channel using SpeedSurf:

Press and hold Channel ▲ or ▼ for about one second. The TV will enter the SpeedSurf mode.

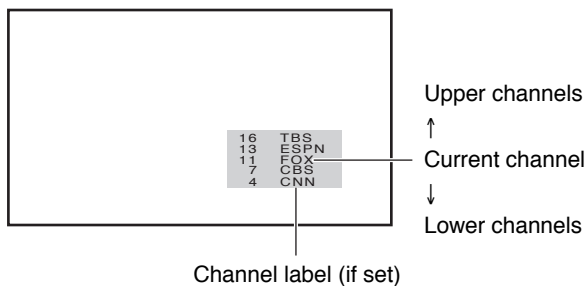

Repeatedly press or hold Channel ▲ or ▼ while the SpeedSurf mode is on-screen to scroll the channel list. Release the button to display the highlighted channel.

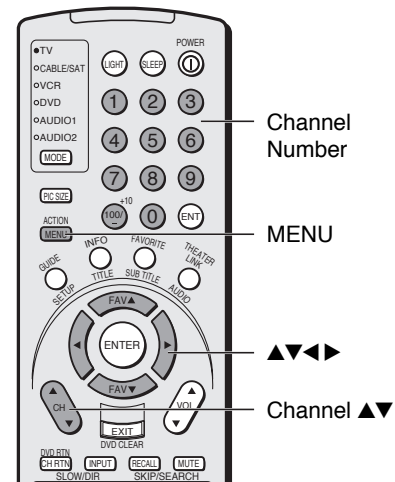
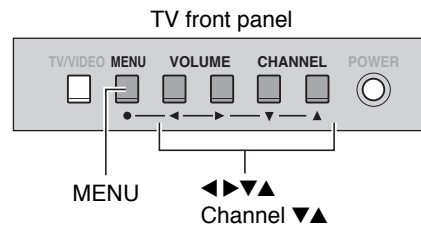

Using the TV's features

Adjusting the channel settings

Switching between two channels using Channel Return

The Channel Return feature allows you to switch between two channels without entering an actual channel number each time.

To switch between two channels:

1. Select the first channel or video mode you want to view.
2. Select a second channel using the Channel Number buttons (0–9, 100).
3. Press CH RTN. The previous channel will be displayed.

Each time you press CH RTN, the TV will switch back and forth between the last two channels that were selected.

Switching between two channels using SurfLock™

The SurfLock™ feature temporarily “memorizes” one channel in the CH RTN button, so you can return to that channel quickly from any other channel by pressing CH RTN.

To memorize a channel in the CH RTN button:

1. Select the channel you want to program into the CH RTN button.
2. Press and hold CH RTN for about 2 seconds until the message “Channel Memorized” appears (flashing) on-screen. The channel has been programmed into the CH RTN button.
3. Continue to change channels.
4. Press CH RTN. The memorized channel will be selected.

The TV will return to the memorized channel one time only. Once you press CH RTN and then change channels again, the CH RTN SurfLock memory will be cleared and the button will function as Channel Return, by switching back and forth between the last two channels that were selected.

Programming your favorite channels

You can preset up to 7 of your favorite channels each for the FAVORITE CH1 and FAVORITE CH2 modes using the Favorite Channel Programming feature. Because this feature scans through only your favorite channels, it allows you to skip other channels you do not normally watch.

To program your favorite channels:

1. Press MENU, and then press ◀ or ▶ until the CUSTOM menu appears.
2. Press ▲ or ▼ to highlight FAVORITE CH1 or FAVORITE CH2.

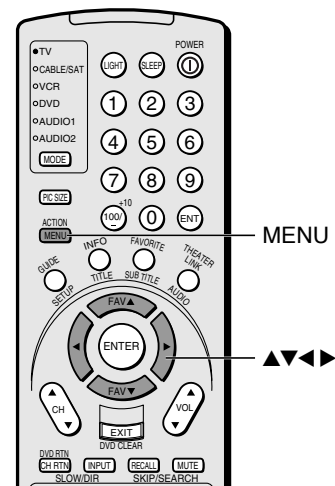
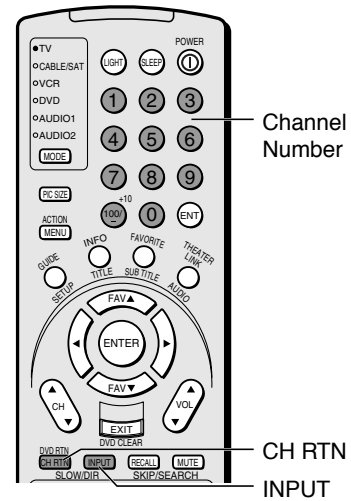
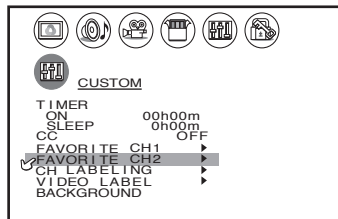
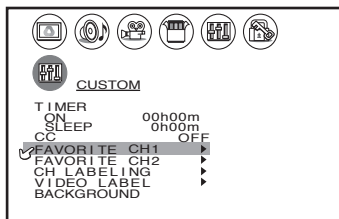

- Press ◀ or ▶ to display the FAVORITE CH1 menu, for example. CH INPUT will be highlighted.

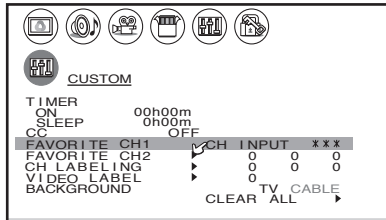

- Press the Channel Number buttons to enter one of your favorite channels.
- Press ENTER.
- Repeat steps 4 and 5 for other channels.

To select your favorite channels:

Press FAV ▲▼.

To quickly scan through your favorite channels in a 7-picture multi-window:

Press FAVORITE (see page 41).

To clear a favorite channel:

- Press MENU, and then press ◀ or ▶ until the CUSTOM menu appears.
- Press ▲ or ▼ to highlight FAVORITE CH2, for example.
- Press ◀ or ▶ to display the FAVORITE CH2 menu.

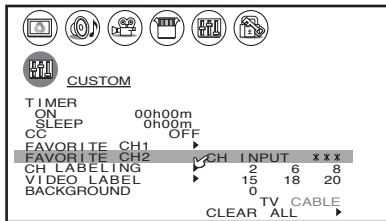

- Press ▲▼◀▶ to highlight the channel you want to clear, and then press ENTER.

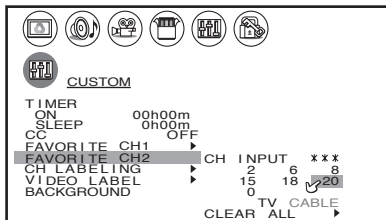

- Repeat step 4 for other channels.

To clear all favorite channels at once:

Press ▲ or ▼ to highlight CLEAR ALL in step 4 above, and then press ◀ or ▶.

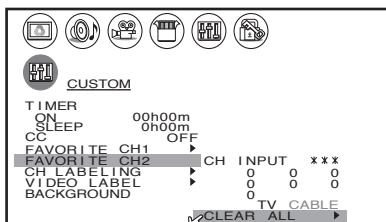

Note:

- The FAV ▲▼ buttons operate as menu ◀▶ buttons when a menu display is on-screen.
- The favorite channel feature is not available in ANT2 mode.

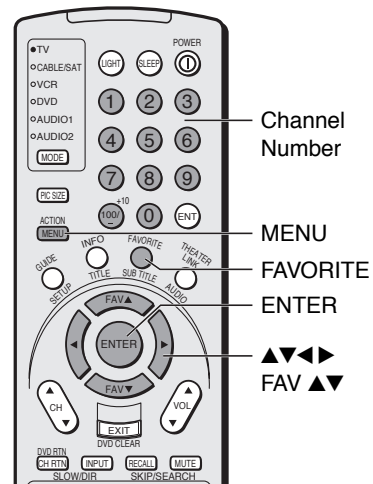

Labeling channels

Channel labels appear above the on-screen channel number display each time you turn on the TV, change the channel, or press RECALL. You can choose any four characters to identify a channel.

To create channel labels:

1. Press MENU, and then press ◀ or ▶ until the CUSTOM menu appears.
2. Press ▲ or ▼ to highlight CH LABELING.
3. Press ◀ or ▶ to display the CH LABELING menu. CH INPUT will be highlighted.

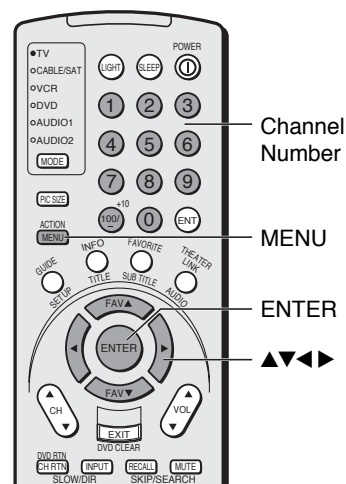
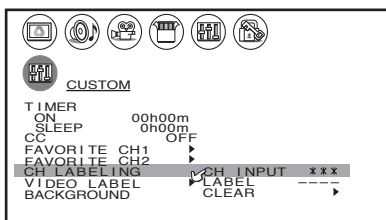

4. Press the Channel Number buttons to select a channel you want to label.

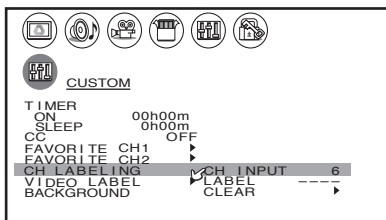

5. Press ▼ to highlight LABEL.
6. Repeatedly press ◀ or ▶ to select a character for the first space, and then press ENTER.

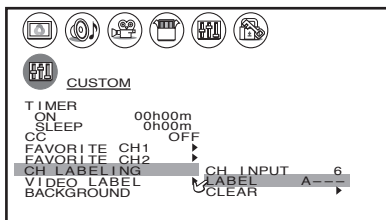

7. Repeat step 6 to enter the rest of the characters.
For a blank space in the label name, choose an empty space from the list of characters; otherwise, a dash “-” will appear in the space.
You must assign a character to all four spaces or the channel will not be labeled.
8. Repeat steps 4–7 for other channels. You can assign labels to a maximum of 32 channels.

To erase a channel label:

1. Press MENU, and then press ◀ or ▶ until the CUSTOM menu appears.
2. Press ▲ or ▼ to highlight CH LABELING.
3. Press ◀ or ▶ to display the CH LABELING menu.
4. Press ▼ to highlight CH INPUT, then select the channel you want to clear with the Channel Number buttons.

(Continued on next page)

5. Press ▼ to highlight CLEAR.
6. Press ◀ or ▶ to erase the channel label.
7. Repeat steps 4–6 to erase other channel labels.

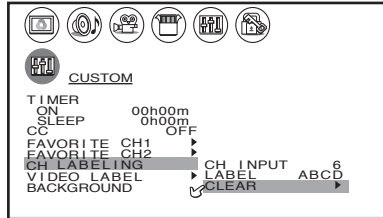

Viewing the wide-screen picture formats

You can view programs in a variety of picture sizes—Natural, Theater Wide 1, Theater Wide 2, Theater Wide 3, and Full.

The way the image displays in any of the picture sizes will vary depending on the format of the program you are viewing. Select the picture size that displays the current program the way that looks best to you.

Selecting the picture size

1. Press PIC SIZE on the remote control.
2. Press the corresponding number button to select the desired picture size, as described below and on the next page.

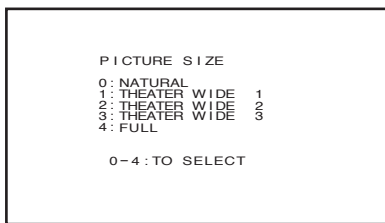

Natural picture size

- The picture is displayed close to its originally formatted proportion. Some program formats will display with side bars and/or bars at the top and bottom (see examples below).

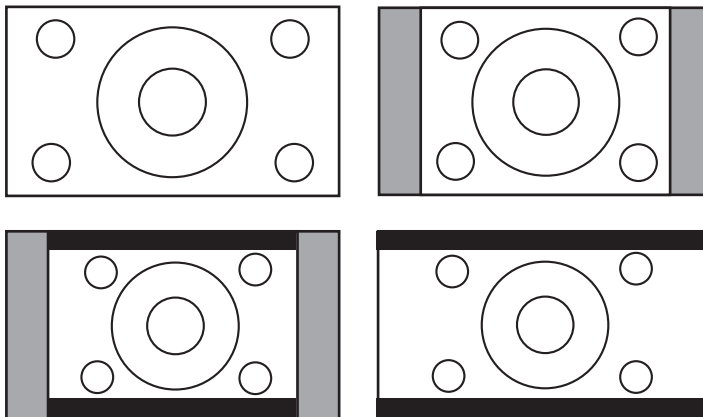

Natural picture size examples: The way the image displays will vary depending on the format of the program you are currently watching.

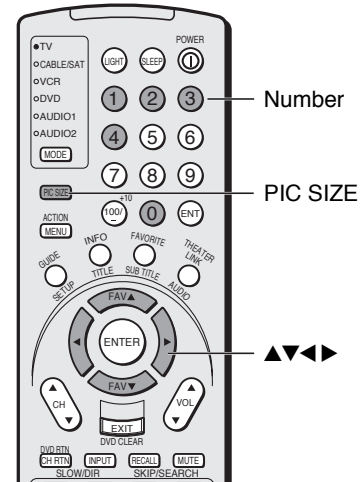

Note:

- The PICTURE SIZE feature may not be available for some program formats.
- You also can change the picture size by selecting PICTURE SIZE in the THEATER menu.

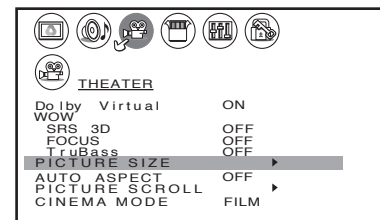

Theater Wide 1 picture size

- The picture is non-uniformly enlarged—the center of the picture remains close to its original proportion, but the left and right edges are stretched wider to fill the screen.
- A small part of the picture at the top and bottom is hidden; however, this mode cannot be scrolled.

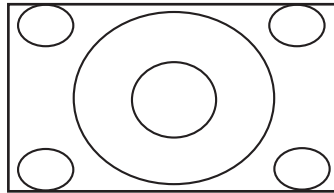

Theater Wide 1 picture size example

Note:

- To select the picture size, press *PIC SIZE* on the remote control or select *PICTURE SIZE* in the *THEATER* menu.
- If you select *Theater Wide 2* or *3*, the top and bottom edges of the picture may be hidden. To see the hidden edges, either scroll the picture (see page 36) or try viewing the program in *Full picture size*.

Theater Wide 2 picture size

- The entire picture is uniformly enlarged—it is stretched the same amount both wider and taller (retains its original proportion).
- Part of the picture at the top and bottom is hidden. To view the hidden areas, see “Scrolling the Theater Wide picture” on page 36.

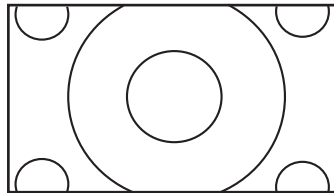

Theater Wide 2 picture size example

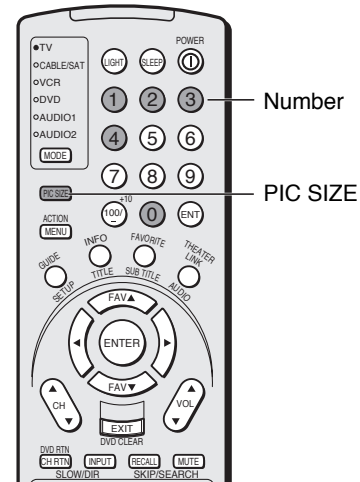

Theater Wide 3 picture size

- The picture is non-uniformly enlarged—it is stretched wider to fill the width of the screen, but only slightly stretched taller.
- A small part of the picture at the top and bottom is hidden. To view the hidden areas, see “Scrolling the Theater Wide picture” on page 36.

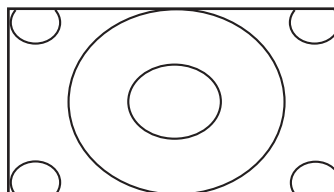

Theater Wide 3 picture size example

Full picture size

- The picture is non-uniformly enlarged—it is stretched wider to fill the width of the screen, but not stretched taller.
- None of the picture is hidden.

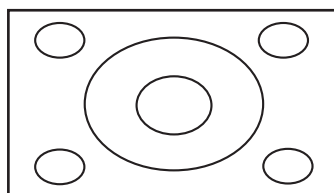

Full picture size example

Scrolling the Theater Wide picture (Theater Wide 2 and 3 only)

1. Press PIC SIZE to select either Theater Wide 2 or 3 mode.
2. Press MENU, and then press ◀ or ▶ until the THEATER menu appears.
3. Press ▲ or ▼ to highlight PICTURE SCROLL.

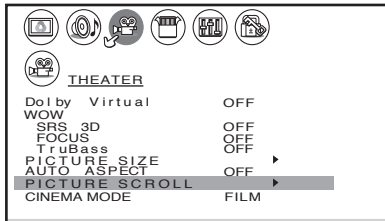

4. Press ◀ or ▶ to display the Scroll Adjustment mode.

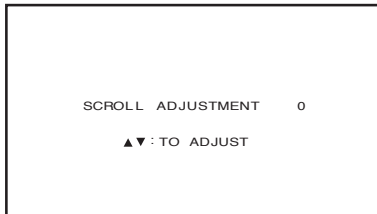

5. Press ▲ or ▼ to adjust the vertical position of the picture.

- Normal (center) position

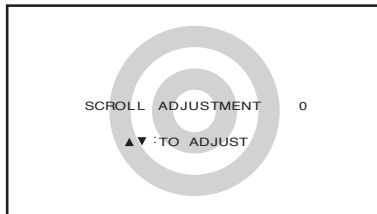

- To raise the picture, press ▲.
- To lower the picture, press ▼.

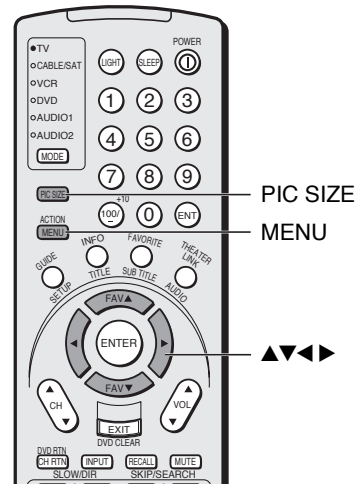
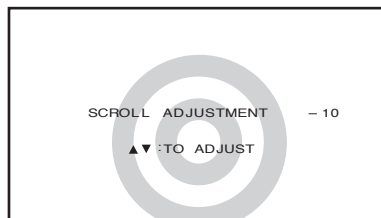
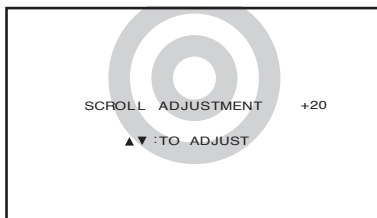

Note:

You can scroll the picture in Theater Wide 2 and Theater Wide 3 only. The scroll amounts are as follows:

Wide 1: Not adjustable

Wide 2: +20 to -10

Wide 3: +20 to -10

Using the auto aspect feature

When receiving 480i signal, the TV will automatically change the picture size by reading aspect information (ID-1 data) from the input signal. If the signal does not include aspect information (ID-1 data), the picture size mode you set is selected.

To turn on the auto aspect:

1. Press MENU, and then press ◀ or ▶ until the THEATER menu appears.

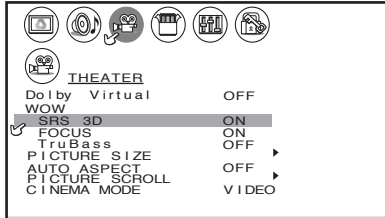

2. Press ▲ or ▼ to highlight AUTO ASPECT, and then press ◀ or ▶ to select ON.

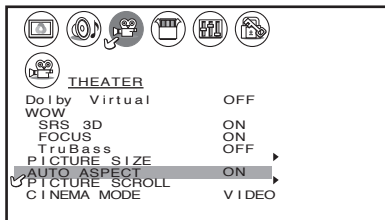

Note:

This feature does not operate for the antenna (cable) and DVI input sources.

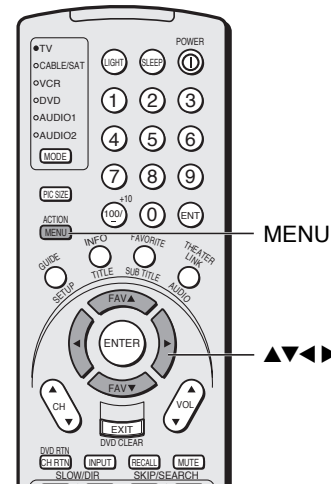

Aspect information (ID-1 data)	Picture size to be selected
4:3 Normal	Natural
16:9 Full	Full
4:3 Letter box	Theater Wide 2
Not Defined	User set mode

Selecting the cinema mode

When you view a DVD movie (3-2 pulldown processed) from a DVD player connected to the ColorStream (component video) or DVI/HDCP inputs on the TV, smoother and more natural motion can be obtained by setting the CINEMA MODE to FILM (auto).

To set the CINEMA MODE to FILM (auto):

1. Press MENU, and then press ◀ or ▶ until the THEATER menu appears.
2. Press ▲ or ▼ to highlight CINEMA MODE.
3. Press ◀ or ▶ to select FILM (auto).

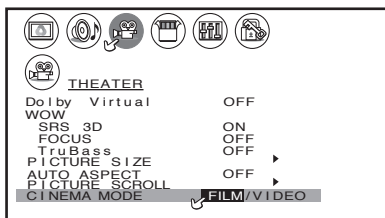

To set the CINEMA MODE to VIDEO (off):

Press ◀ or ▶ to select VIDEO in step 3 above.

Using the POP double-window feature

The POP (picture-out-picture) feature splits the screen into a double window that allows you to watch two programs at the same time. The POP program can come from a TV broadcast or an external source, such as a VCR.

To display a TV broadcast in the POP window:

1. Press SPLIT to display the POP window.

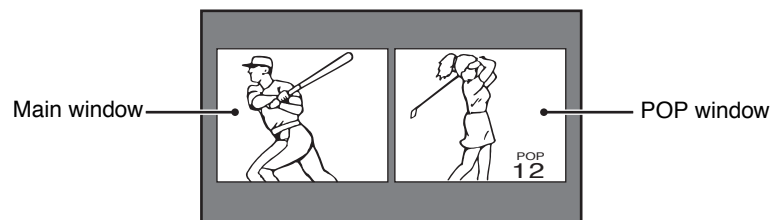

2. Select channels of the POP window in the following two ways:

- To change to a specific channels, press POP DIRECT CH. While "POP" is on the screen, press the Channel Number buttons (0-9 and 100).
- To change the next programmed channels, press POP CH ▲▼.

If the V-CHIP feature is active and you try to watch a TV program that exceeds your set rating limits, the program will be blocked (see "Using the V-CHIP menu" on page 43).

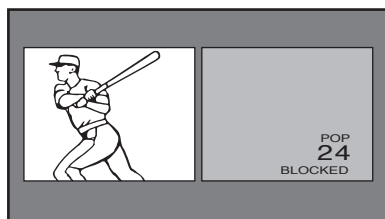

To display a picture from an external source in the POP window:

1. Connect the external source equipment (see "Connecting your TV" on page 8).
2. Select the TV program you want to watch in the main window.
3. Press SPLIT to display the POP window.
4. Repeatedly press SOURCE to select the input source for the POP window (VIDEO 1, VIDEO 2, VIDEO 3, ColorStream HD1, or ColorStream HD2 only; you cannot select DVI in POP mode). The current source will display in purple.
5. You can play a tape as the POP picture, or select a channel for the POP window using the VCR's channel keys.

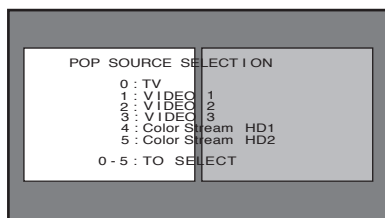

While the above menu is on the screen, you can select the desired signal input source by pressing the corresponding number button (0-5).

To close the POP window:

Press SPLIT again or EXIT.

Note:

- The SPLIT buttons on the remote control operate the TV's POP features.
- You cannot access POP features when viewing DVI input.
- You cannot display the ANT-2 signal source in the POP window.
- You can choose to hear the sound of either the main or POP program (see "Selecting the Audio OUT sound" on page 58).

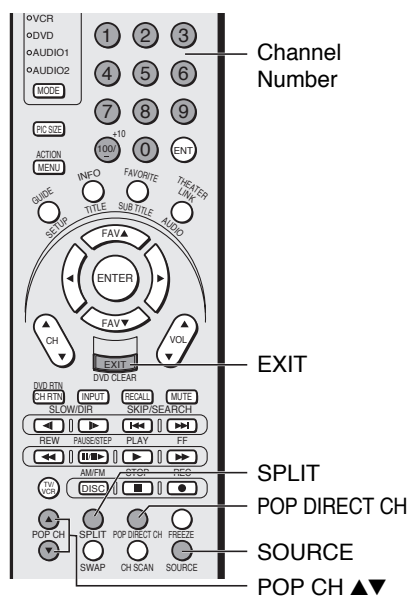

Switching the main and POP pictures

Press SWAP while you are using the POP feature to switch the main and POP pictures.

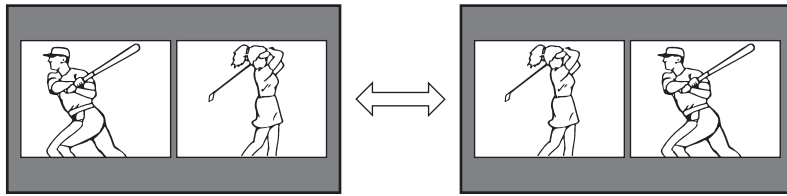

Freezing the POP picture

1. Press FREEZE while the POP is not on the screen. The POP window will appear with a still picture.
2. Press FREEZE again to renew the still picture.

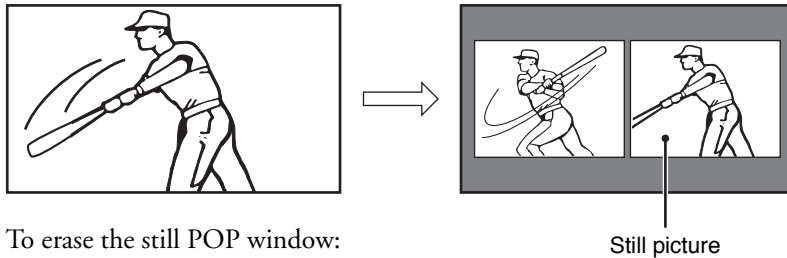

To erase the still POP window:
Press EXIT.

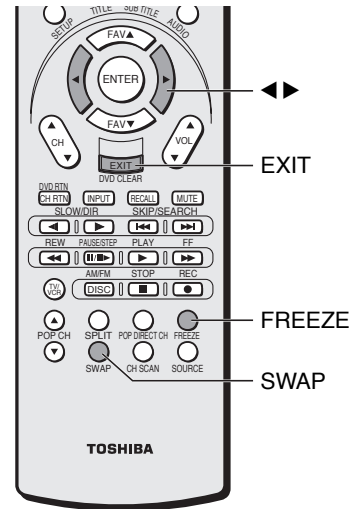

Adjusting the size of the double-window

When the input signals of the main and POP pictures are 480i, you can adjust the size of each window. Continuously pressing ◀ or ▶ changes the size in 9 steps.

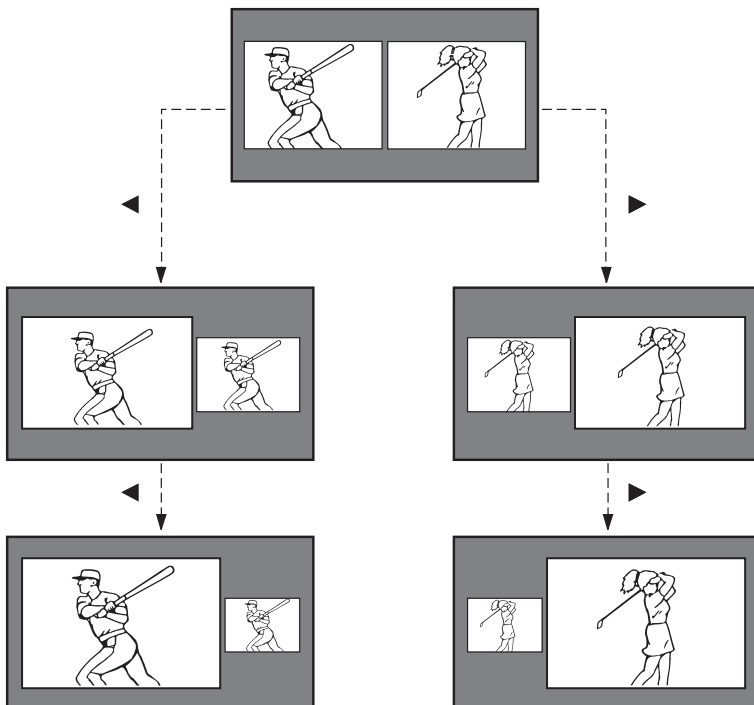

Note:

If the signal format other than 480i is received, this feature is not available. "Not available" will appear on the screen.

Double-Window with keeping aspect ratio

The Double-Window displays the pictures with various aspect ratio according to the input signal format.

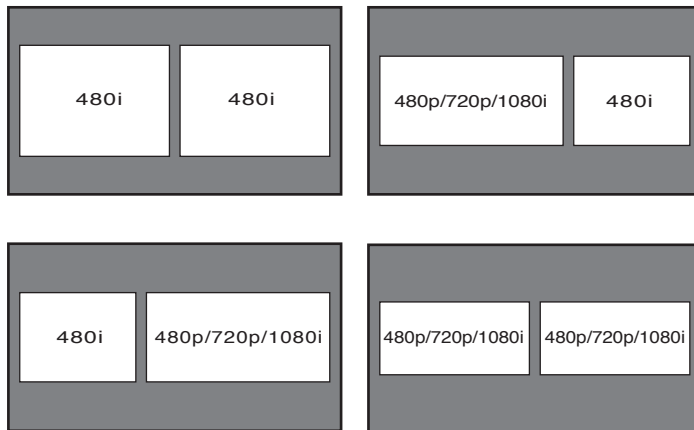

Using the programmed channel search function

You can use the programmed channel search function to quickly scan your programmed channels (see “Adding channels to TV’s memory” on page 29).

1. Press CH SCAN.

The TV automatically enters POP mode, and begins a seven-picture scan of your programmed channels in the POP window.

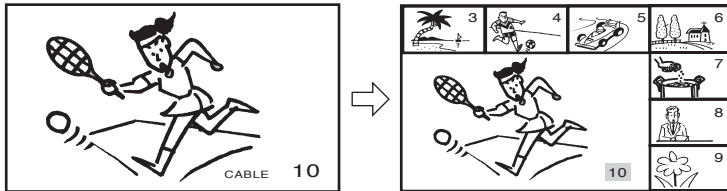

2. Press ▲▼◀▶ to select one of the seven pictures (becomes a moving picture). The main picture is an always moving picture.
3. Press ENTER to display the channel you selected in step 2 as a normal picture.

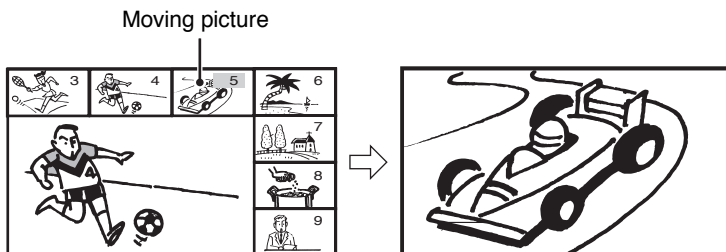

Note:

The auto aspect feature does not operate in the Double-Window mode.

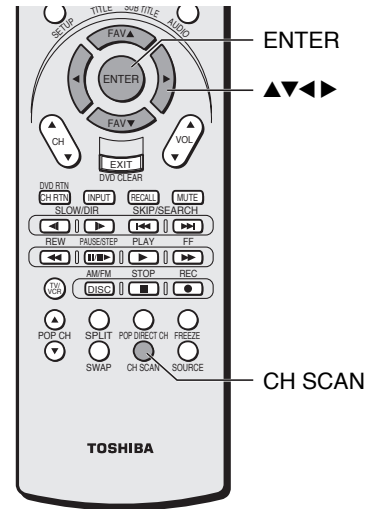

Note:

The aspect ratio of all main and POP windows are 16:9.

Using the favorite channel search function

You can use the favorite channel search function to quickly scan your favorite channels (see “Programming your favorite channels” on page 31).

1. Press FAVORITE.
The TV automatically enters POP mode, and begins a seven-picture scan of your favorite channels in the POP window.

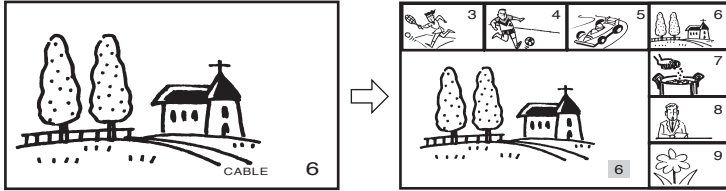

2. Press ▲▼◀▶ to select one of the seven pictures (becomes a moving picture). The main picture is an always moving picture.
3. Press ENTER to display the channel you selected in step 2 as a normal picture.

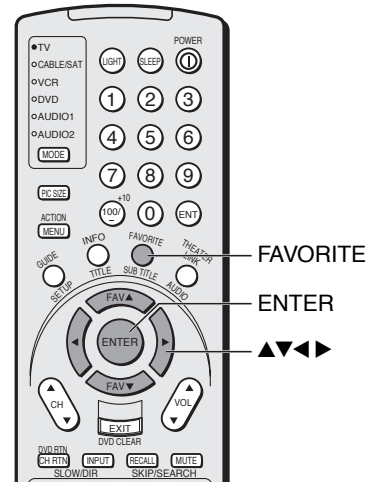
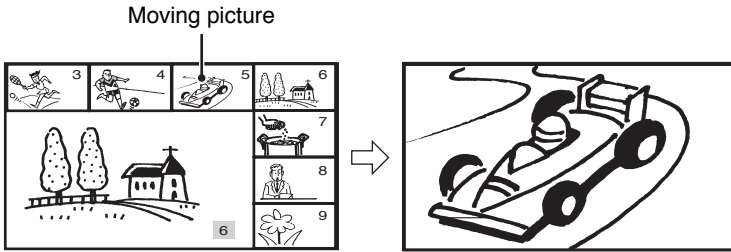

Note:
This feature does not operate in the DVI mode.

Every time you press FAVORITE, the POP window scans your favorite channels in the following order:

FAVORITE CH1 — FAVORITE CH2 — Off

About the auto favorite feature

If your TV is in the program lock mode, after 4 seconds, the TV starts the auto favorite channel search function. See page 46 for details.

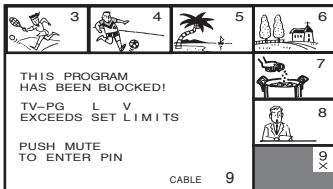

Using the LOCKS menu

The LOCKS menu includes the V-Chip, CH Lock, Video Lock, and New PIN Code functions. You can use these functions after entering the correct PIN code.

Entering the PIN code

1. Press MENU, and then press ◀ or ▶ until the LOCKS menu appears.

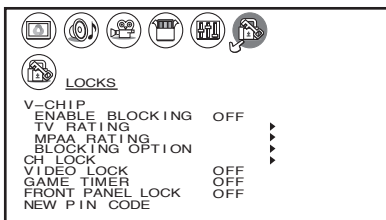

2. Press ▲ or ▼ to display the PIN code entering mode.
 - Blocking Reset status: Set your 4-digit code by pressing the Number buttons (0-9), and then press ENTER.
 - When the PIN code is already stored: Press the Number buttons (0-9) to enter the 4-digit PIN code used for blocking channels, and then press ENTER.



If the wrong PIN code is entered, the message “Incorrect” appears. Enter the code again, and then press ENTER.

If you cannot remember your PIN code

While the PIN code entering screen is displayed, press RECALL four times within five seconds. The PIN code will be released (blocking reset status restored).

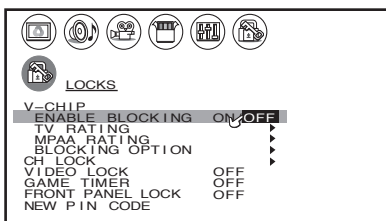

Continue to set each item following the steps on the next page.

Note:

The V-Chip function is available only for the U.S. V-Chip system. The Canadian V-Chip system is not supported.

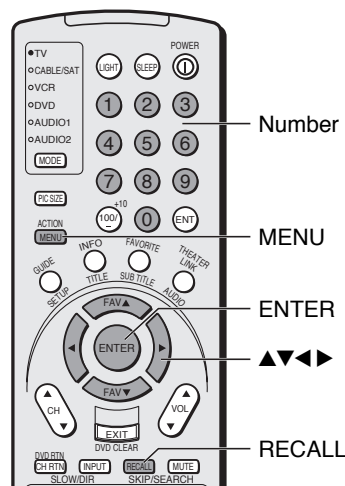

Using the V-CHIP menu

Some TV programs and movies include signals that classify the content of the program (dialog, language, sex, violence). The V-CHIP control feature in this TV detects the signals and blocks the programs according to your selections. To use this feature, perform the following setup.

ENABLE BLOCKING

1. From the LOCKS menu, select ENABLE BLOCKING.
2. Press ◀ or ▶ to select ON or OFF.
ON : To enable your V-CHIP setting (Lock)
OFF: To release your V-CHIP setting (Unlock)

Note: The CH LOCK function is not affected by the ENABLE BLOCKING setting.

TV RATING (Independent rating system for broadcasters)

1. From the LOCKS menu, select TV RATING.
2. Press ◀ or ▶ to display the TV RATING menu.
3. Press ▼ or ▲ to select item.
4. Press ▶ to lock (displays “X”)
Press ◀ to unlock (displays “✓”)
5. Repeat steps 3 and 4 to set the next item.

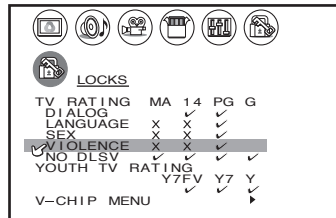

The age-based TV ratings and content themes you can lock are listed in the table below.

Ratings	Description and Content themes
MA	Mature Audience Only (This program is specifically designed to be viewed by adults and therefore may be unsuitable for children under 17.) L) Crude or indecent language S) Explicit sexual activity V) Graphic violence
14	Parents Strongly Cautioned (This program contains some material that many parents would find unsuitable for children under 14 years of age.) D) Intensely suggestive dialog L) Strong, coarse language S) Intense sexual situations V) Intense violence
PG	Parental Guidance Suggested (This program contains material that parents may find unsuitable for younger children.) D) Some suggestive dialog L) Infrequent coarse language S) Some sexual situations V) Moderate violence
G	General Audience (Most parents would find this program suitable for all ages.)
Y7, Y7FV	Directed to Older Children (This program is designed for children age 7 and above. Note: Programs in which fantasy violence may be more intense or more combative than other programs in this category are designated Y7FV.)
Y	All Children (This program is designed to be appropriate for all children)

Note:

The V-Chip function is available only for the U.S. V-Chip system. The Canadian V-Chip system is not supported.

LOCKS menu

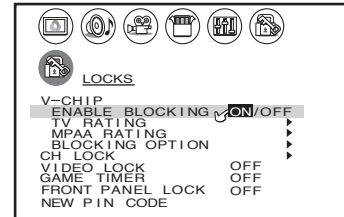

To select each item:

Press ▼ or ▲.

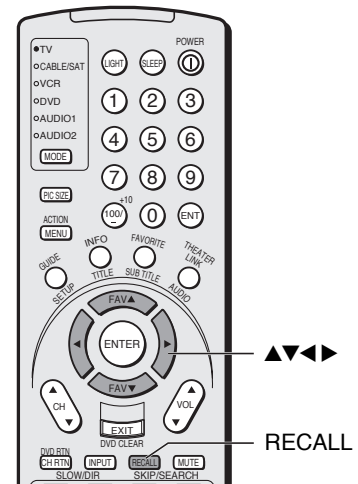

Press RECALL to display the rating of the TV program you are currently watching.

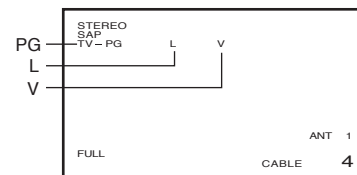

MPAA RATING (Independent rating system for movies)

1. From the LOCKS menu, select MPAA RATING.
2. Press ◀ or ▶ to display the MPAA RATING menu, and then press ▼ or ▲ to highlight MPAA RATING.

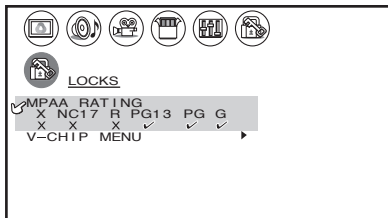

3. Press ▶ to lock ("X") or press ◀ to unlock ("✓").

The movie ratings you can lock are described as follows:

- X : X-rated (For adults only)
- NC17: Not intended for anyone 17 and under
- R : Restricted (Under 17 requires accompanying parent or adult guardian.)
- PG13 : Parents Strongly Cautioned (Some material may be inappropriate for children under 13)
- PG : Parental Guidance Suggested (Some material may not be suitable for children)
- G : General Audience (Appropriate for all ages)

BLOCKING OPTION

1. From the LOCKS menu, select BLOCKING OPTION.
2. Press ◀ or ▶ to display the BLOCKING OPTION menu, and then press ▲ or ▼ to select an item, as follows:

MPAA UNRATED:

Press ◀ or ▶ to select ON (lock) or OFF (unlock) for unrated programs in the MPAA rating system.

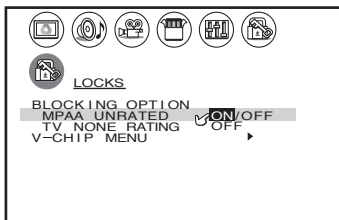
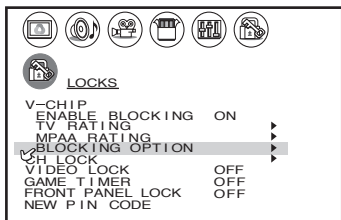

TV NONE RATING

Press ◀ or ▶ to select ON (lock) or OFF (unlock) for programs rated NONE in the TV PARENTAL GUIDELINES.

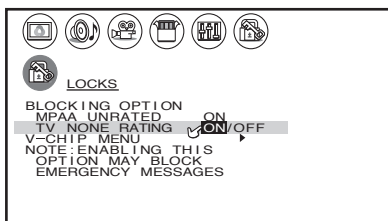

V-CHIP MENU:

Press ◀ or ▶ to return to the LOCKS menu.

LOCKS menu

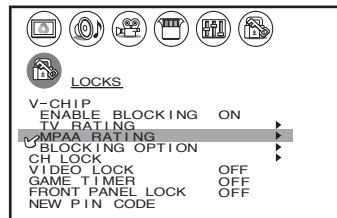

To select each item:

Press ▼ or ▲.



Caution

Setting the TV NONE RATING to ON may block the broadcast of emergency information. The menu will display the note, "Enabling this option may block emergency messages" to warn you of this possibility.

Unlocking programs temporarily

1. If you try to watch a TV program that exceeds the rating limits you set, the TV enters program lock mode. After 4 seconds, the TV starts the favorite channel search function (see page 41). You can either unlock the program temporarily (see steps 2 and 3) or select a non-locked program to watch.

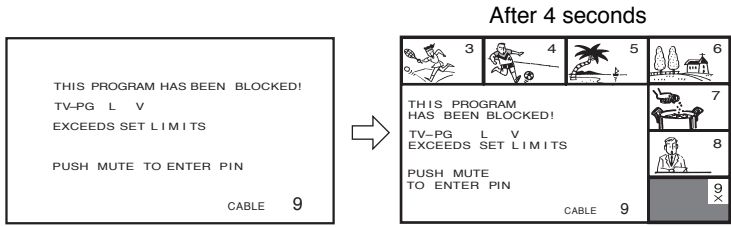

2. To temporarily unlock the program, press MUTE.
3. Press the Number buttons (0–9) to enter your 4-digit PIN code, and then press Enter.

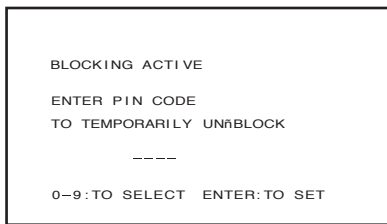

If the correct code is entered, the program lock mode is released and the normal picture appears.

All locking is disabled until the TV is turned off, and will be enabled when the TV is turned on again.

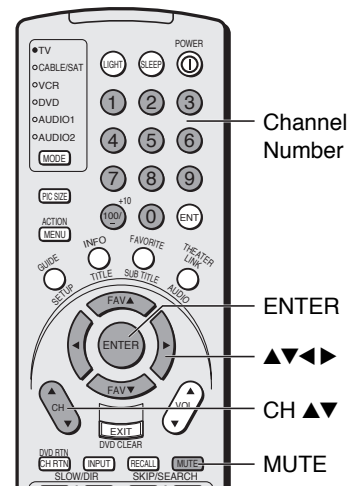

Locking channels

You can use the CH LOCK feature to lock specific channels. You will not be able to tune locked channels with either the Channel ▲▼ buttons or Channel Number buttons, unless you clear the setting.

You can lock a maximum of nine channels.

To lock channels:

1. From the LOCKS menu, select CH LOCK.
2. Press ◀ or ▶ to display the CH LOCK menu. CH INPUT will be highlighted.
3. Press the Channel Number buttons to enter the channel you want to lock.
4. Press ENTER.

LOCKS menu

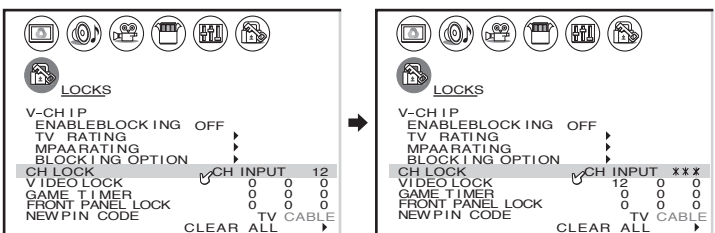
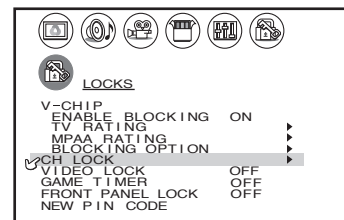

To select each item:

Press ▼ or ▲.

5. Repeat steps 3 and 4 for other channels.

To unlock channels:

1. From the LOCKS menu, select CH LOCK.
2. Press ◀ or ▶ to display the CH LOCK menu.
3. Press ▲▼◀▶ to highlight the channel you want to unlock, and then press ENTER.

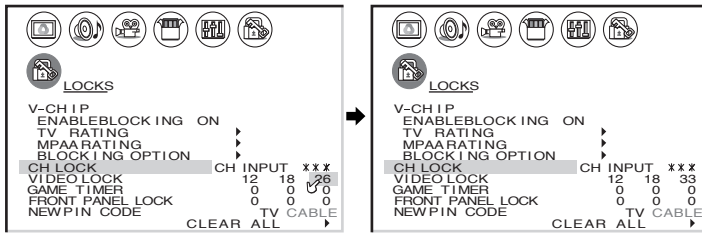

4. Repeat step 3 for other channels you want to unlock.

To clear all locked channels at once:

Press ▲ or ▼ to highlight CLEAR ALL in step 3 above, and then press ▶ or ◀.

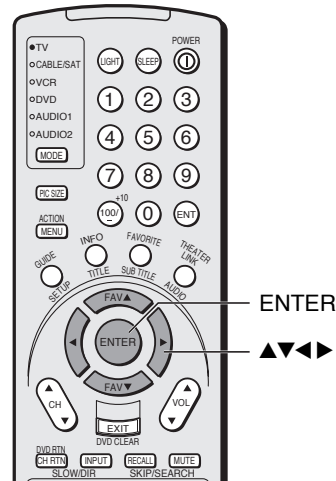
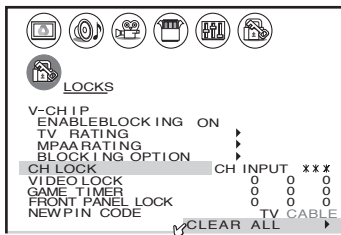

Locking video inputs

You can use the VIDEO LOCK feature to lock out the video input sources (VIDEO 1, VIDEO 2, VIDEO 3, ColorStream HD1, ColorStream HD2, DVI) and channels 3 and 4.

You will not be able to select the locked input sources with the TV/VIDEO, INPUT, or Channel button unless you clear the setting.

To set up the video lock:

1. From the LOCKS menu, select VIDEO LOCK.
2. Press ◀ or ▶ to highlight the level of video locking you want, as follows:

VIDEO : Locks VIDEO 1, VIDEO 2, VIDEO 3, ColorStream HD1/HD2, and DVI.

VIDEO+ : Locks VIDEO 1, VIDEO 2, VIDEO 3, ColorStream HD1/HD2, DVI, and channels 3 and 4.

Select VIDEO+ if you use the antenna terminal to play a video tape.

OFF : Unlocks all video input sources.

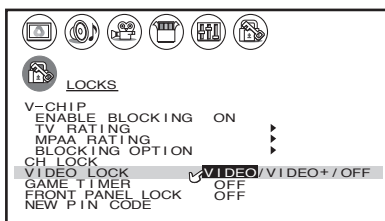

Using the game timer

This feature allows you to restrict the time which has chosen the video mode. When the time set up beforehand is passed, the last tuned channel will be selected automatically (The VIDEO LOCK is set to VIDEO).

To set the game timer:

1. From the LOCKS menu, select GAME TIMER.
2. Press ◀ or ▶ to select the length of time until the video mode is blocked from among 30, 60, 90 and 120 minutes. When the number is highlighted, the timer will start countdown.

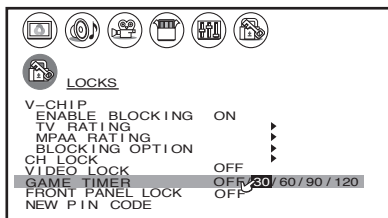

To cancel the timer:

Select OFF in step 2 above.

Using the front panel lock feature

Lock the front panel buttons to prevent the buttons from being pressed accidentally (by children, for example). When the front panel lock is in ON, all control buttons on the TV front panel (except POWER) do not operate.

To lock the front panel:

1. From the LOCKS menu, select FRONT PANEL LOCK.
2. Press ◀ or ▶ to highlight ON.

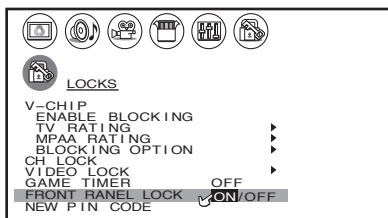

If a button on the front panel is pressed, the message “Not Available” appears.

To unlock the front panel:

Highlight OFF in step 2 above, or press and hold the VOL ◀ button on the TV for about 10 seconds until the message “Front Panel Lock: Off” appears on the screen.

Changing the PIN code

1. From the LOCKS menu, select NEW PIN CODE.
2. Press the Number buttons (0-9) to enter a 4-digit code. The numbers you enter will replace the dashes in the display.

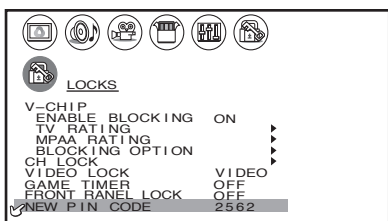

3. Press ENTER. The new PIN code is now active.

Note:

After the game timer set is operated, set the VIDEO LOCK to “OFF” is necessary.

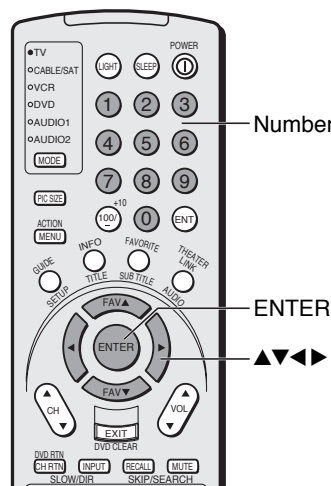
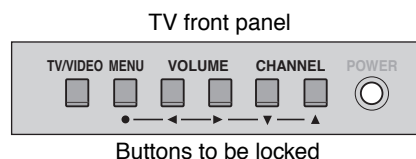

Adjusting the picture

Selecting the picture mode

You can select from four picture modes: Sports, Standard, Movie, and Preference.

Mode	Picture Quality
Sports	Bright and dynamic picture (factory setting)
Standard	Standard picture setting (factory setting)
Movie	Movie-like picture setting (factory setting)
Preference	Your personal preferences*

*(see “Saving your new preferences” on page 49.)

To select the picture mode:

1. Press MENU, and then press ◀ or ▶ until the PICTURE menu appears.
2. Press ▼ or ▲ to select MODE.
3. Press ◀ or ▶ to highlight the mode you prefer.

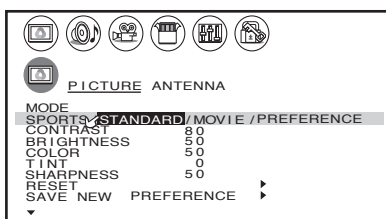

Adjusting the picture quality

You can adjust the picture quality to your personal preferences, including the contrast, brightness, color, tint, sharpness.

Selection	◀ Pressing ▶	
contrast	lower	higher
brightness	darker	lighter
color	paler	deeper
tint	reddish	greenish
sharpness	softer	sharper

To adjust the picture quality:

1. Press MENU, and then press ◀ or ▶ until the PICTURE menu appears.
2. Press ▼ or ▲ until the item you want to adjust is highlighted.
3. Press ◀ or ▶ to adjust the level.

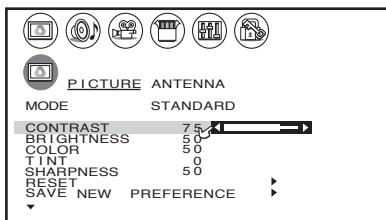

The PICTURE qualities you adjusted can be saved in the TV's memory with the SAVE NEW PREFERENCE feature (see page 49). You can keep these settings or choose factory set options, as described under “Selecting the picture mode” above.

Note:

If you select one of the factory-set picture modes (SPORTS, STANDARDS, or MOVIE) and then change a picture quality setting (e.g. increase the contrast), the picture mode automatically changes to PREFERENCE in the Picture menu.

To save your new picture quality settings, you must select SAVE NEW PREFERENCE (see page 49) before closing the Picture menu or the TV will return to the previous picture mode.

TV front panel

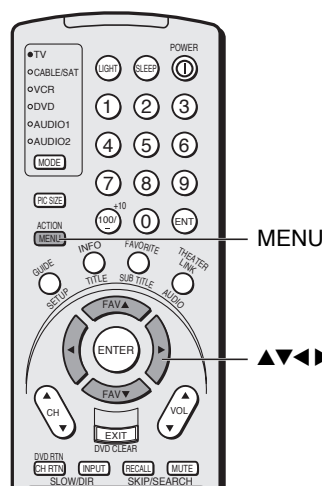
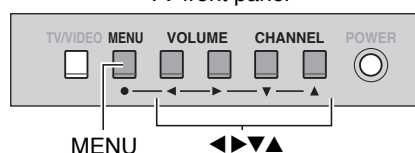

Saving your new preferences

You can save the picture qualities you adjusted (contrast, brightness, color, tint, and sharpness) in the PICTURE menu PREFERENCE mode.

To save your new preferences:

1. Press MENU, and then press ◀ or ▶ until the PICTURE menu appears.
2. Press ▲ or ▼ to highlight SAVE NEW PREFERENCE.
3. Press ◀ or ▶. The menu displays “DONE.”

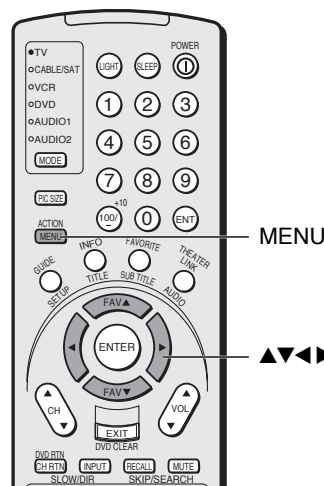
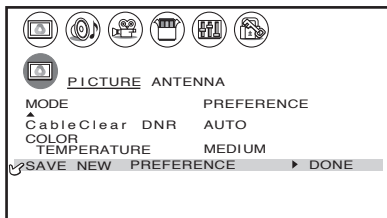

You can choose your saved preferences by selecting PREFERENCE (see “Selecting the picture mode” on page 48).

Using CableClear™ DNR (Digital Noise Reduction)

CableClear™ DNR reduces visible interference in your TV picture. This is useful when receiving a broadcast with a weak signal or playing back a video cassette or disc damaged by repeated use.

To turn on CableClear DNR:

1. Press MENU, and then press ◀ or ▶ until the PICTURE menu appears.
2. Press ▲ or ▼ to highlight CableClear DNR.
3. Press ◀ or ▶ to highlight AUTO.

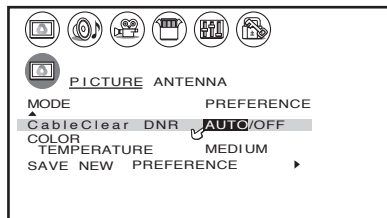

Note:

The “CableClear DNR” menu listing will change to “DNR” in VIDEO mode.

To turn off CableClear DNR:

Highlight OFF in step 3 above.

Selecting the color temperature

You can change the quality of the picture by selecting from three preset color temperatures: cool, medium, and warm.

Mode	Picture Quality
cool	blueish
medium	neutral
warm	reddish

To select the color temperature:

1. Press MENU, and then press ◀ or ▶ until the PICTURE menu appears.
2. Press ▲ or ▼ to highlight COLOR TEMPERATURE.
3. Press ◀ or ▶ to highlight the mode you prefer.

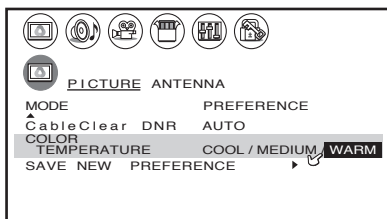

Resetting your picture quality adjustments

The RESET function returns the picture quality adjustments to the following factory settings:

Contrast	max (100)	Color temperature	cool
Brightness	center (50)	DNR	auto
Color	center (50)	Mode	sports
Tint	center (0)		
Sharpness	center (50)		

To reset your picture quality adjustments:

1. Press MENU, and then press ◀ or ▶ until the PICTURE menu appears.
2. Press ▲ or ▼ to highlight RESET.
3. Press ◀ or ▶. The menu displays “DONE.”

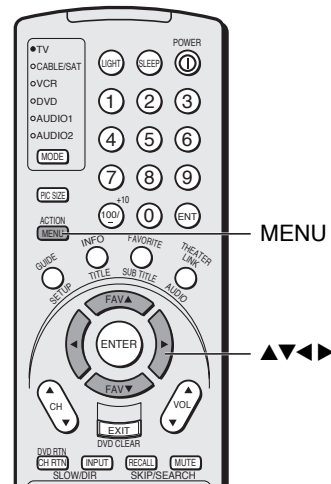
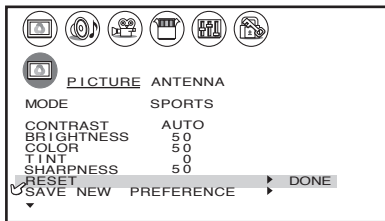

Selecting the video input source

Press INPUT on the remote control or TV/VIDEO on the TV to view a signal coming from another device connected to your TV, such as a VCR or video disc player (see illustrations below). You can select ANT 1, VIDEO 1, VIDEO 2, VIDEO 3, ColorStream HD1, ColorStream HD2, DVI, or ANT 2 depending on which input terminals are used to connect your devices (see “Connecting your TV” on pages 9-18.)

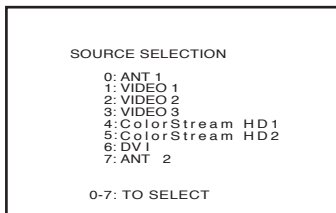

Pressing INPUT on the remote control displays the current signal source (press INPUT again or 0-7 to change)

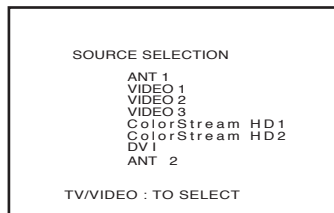

Pressing TV/VIDEO on the TV changes the current signal source

Note:

- When ColorStream HD1/HD2, or DVI is selected, the VIDEO OUT jack does not output a signal. To receive a VIDEO OUT signal, use a standard video or S-video IN connection instead.
- If you select ColorStream HD1/HD2, DVI while the POP picture is active, the POP window will close.

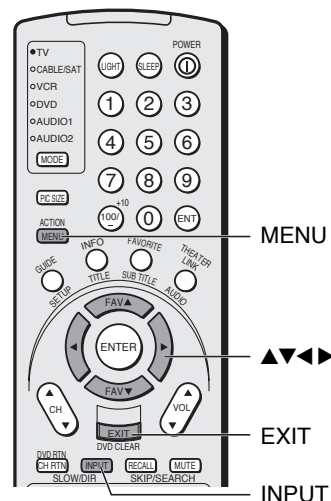
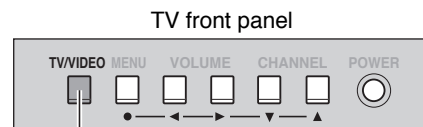

Labeling the video input sources

The video label feature allows you to label each input source for your TV from the following preset list of labels:

- : Uses the default label name
- VCR : Video cassette recorder
- DVD : DVD video
- DTV : Digital TV set-top box
- SAT : Satellite box
- CBL : Cable box
- HD : DVI/HDCP device (see page 15)

To label the video input sources:

1. Press MENU, and then press ◀ or ▶ until the CUSTOM menu appears.
2. Press ▲ or ▼ to highlight VIDEO LABEL.

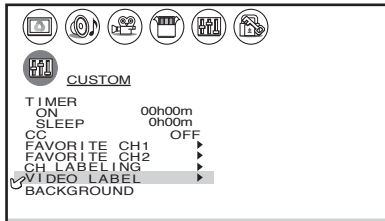

3. Press ◀ or ▶ to display the VIDEO LABEL menu.
4. Press ▲ or ▼ to highlight the video source you want to label.
5. Repeatedly press ◀ or ▶ to select the desired label for that input source.

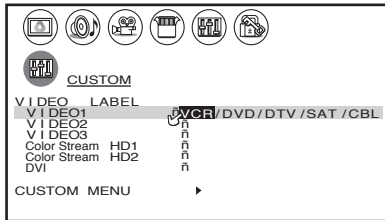

6. Finish labeling the other video sources as desired. To return to the previous menu, press ▲ or ▼ to highlight CUSTOM MENU, and then press ◀ or ▶.
7. To exit the menu, press EXIT.

Selecting the background of the menu display

You can change the background of the menu display by selecting from two preset types: shaded and solid (gray).

To select the background:

1. Press MENU, and then press ◀ or ▶ until the CUSTOM menu appears.
2. Press ▲ or ▼ to highlight BACKGROUND.
3. Press ◀ or ▶ to select either a SHADED or SOLID background.

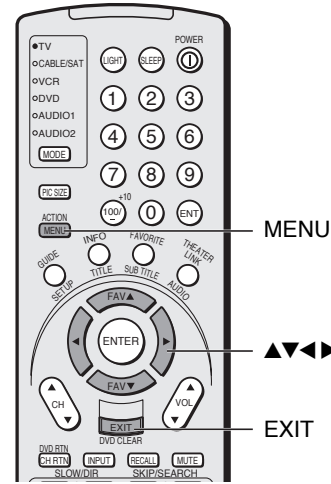
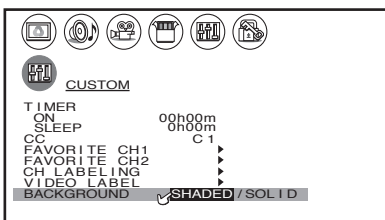

Note:

The HD (high-definition) label is available for DVI mode only (see “Selecting the video input source,” above, and “Connecting a device to the DVI/HDCP IN terminal” on page 15).

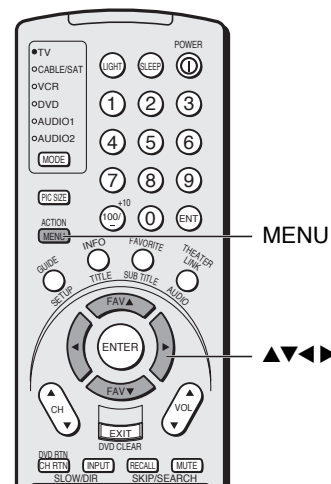

Using the closed caption feature

The closed caption feature has two options:

- Captions—An on-screen display of the dialogue, narration, and sound effects of TV programs and videos that are closed captioned (usually marked as “CC” in TV listings).
- Text—An on-screen display of information not related to the current program, such as weather or stock data (when provided by individual stations).

To view captions or text:

1. Tune the TV to the desired program.
2. Press MENU, and then press ◀ or ▶ until the CUSTOM menu appears.
3. Press ▼ or ▲ to highlight CC.

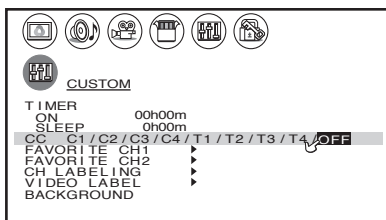

4. Press ◀ or ▶ to highlight the desired closed caption mode, as follows:

- To view captions, highlight C1, C2, C3, or C4 (C1 displays translation of the primary language in your area).

Note: If the program or video you selected is not closed captioned, no captions will display on-screen.



- To view text, highlight T1, T2, T3, or T4.

Note: If text is not available in your area, a black rectangle may appear on-screen. If this happens, turn off the Closed Caption feature.

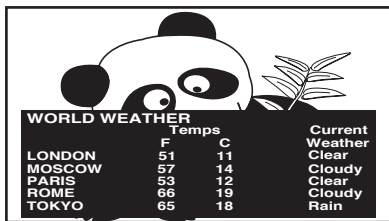

To turn off the Closed Caption feature:

Highlight OFF in step 4 above.

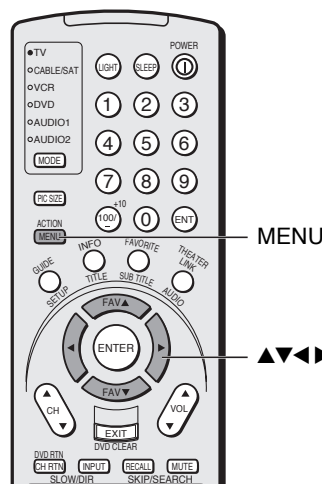

Note:

A closed caption signal may not display in the following situations:

- when a videotape has been dubbed
- when the signal reception is weak
- when the signal reception is nonstandard

Setting the ON-timer

To set the ON-timer to turn the TV on automatically:

1. Press MENU, and then press ◀ or ▶ until the CUSTOM menu appears.
2. Press ▲ or ▼ to highlight ON.
3. After the number position starts to blink, press the Number buttons (0-9) to enter the length of time until the TV turns on automatically.
You can set the ON-timer by 10 minutes, up to 12h00m.
4. Press ENTER to start the timer.

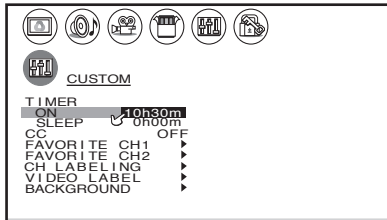

5. Press POWER to turn off the TV.
The TV will turn on automatically after the time you preset.

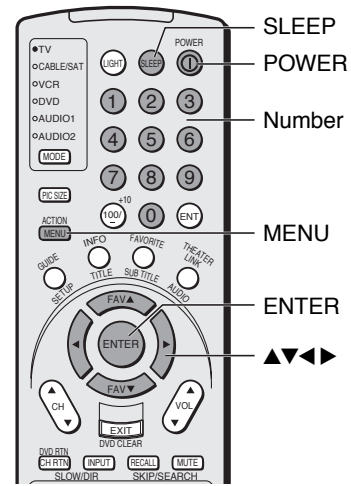

Setting the sleep timer

To set the sleep timer to turn the TV off automatically:

1. Press SLEEP to set the length of time until the TV turns off.

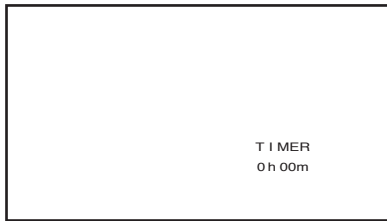

Every time you press the button, the time display will increase by 10 minutes, up to 3 hours.

0h00m → 0h10m → 0h20m ----- → 2h50m → 3h00m → 0h00m

To cancel the sleep timer:

Press SLEEP until it is set to 0h00m.

The timer can also be set using the on-screen menu:

1. Press MENU, and then press ◀ or ▶ until the CUSTOM menu appears.
2. Press ▲ or ▼ to highlight SLEEP.
3. After the number position starts to blink, press the Number buttons (0-9) to enter the length of time until the TV turns off automatically.
4. Press ENTER to start the timer.

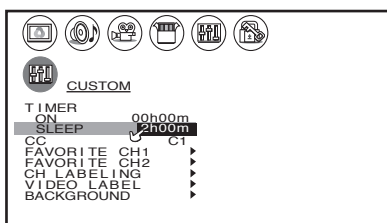

Note :

When an instant power failure occurs, the timer setting may be cleared.

To display the amount of time left until the TV turns on or off automatically, press RECALL.

Adjusting the sound

Muting the sound

Press MUTE to temporarily reduce (1/2 MUTE) or turn off (MUTE) the sound. While the sound is reduced, the screen display “1/2 MUTE” or “MUTE” in the lower right corner. Each time you press MUTE, the mute mode will change in the following order.

→ Normal → 1/2 MUTE → MUTE →

When you select “MUTE” mode, the closed caption feature is automatically activated. To deactivate this feature, deactivate MUTE. This feature works only when the closed caption mode is set to OFF. See “Using the closed caption feature” on page 52 for more information.

Selecting stereo/SAP broadcasts

The multi-channel TV sound (MTS) feature allows you to listen to high-fidelity stereo sound while watching TV. MTS can also transmit a second audio program (SAP) containing a second language, music, or other audio information (when provided by individual stations).

When the TV receives a stereo or SAP broadcast, the word STEREO or SAP appears on-screen every time the TV is turned on, the channel is changed, or the RECALL button is pressed.

The MTS feature is not available when the TV is in VIDEO mode.

To listen to stereo sound:

1. Press MENU, and then press ◀ or ▶ until the AUDIO menu appears.
2. Press ▲ or ▼ to highlight MTS.
3. Press ◀ or ▶ to highlight STEREO.

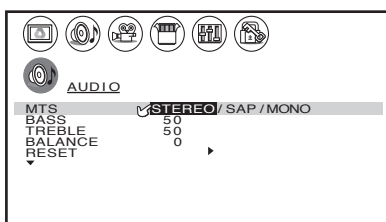

You can leave your TV in STEREO mode because it will automatically output the type of sound being broadcast (stereo or monaural). The word “STEREO” or “SAP” displays in yellow in the menu when the TV receives the signal.

If the stereo sound is noisy, select MONO to reduce the noise.

To listen to SAP (if available):

1. Press MENU, and then press ◀ or ▶ until the AUDIO menu appears.
2. Press ▲ or ▼ to highlight MTS.
3. Press ◀ or ▶ to highlight SAP. You will hear the station’s second audio program (if available) from the speakers, while viewing the original program’s picture (see note at right).

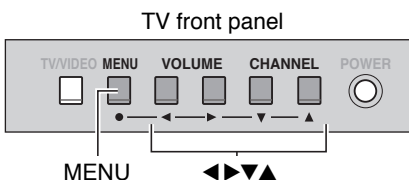
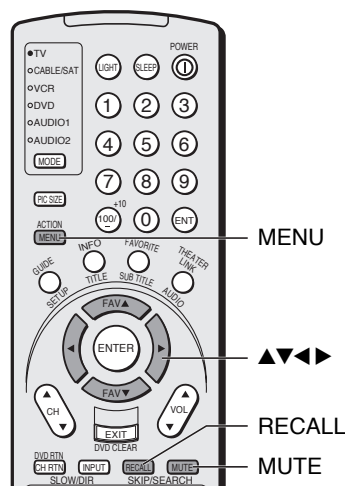

Note :

A second audio program (SAP) can be heard only on those TV stations that offer it.

For example, a station might broadcast music as a second audio program. If you have SAP on, you will see the current program on the screen but hear music instead of the program’s normal audio.



If you have SAP on and the station you are watching is not currently broadcasting a second audio program, the station’s normal audio will be output.

However, occasionally there is no sound at all in this instance.

If this happens, set the MTS feature to STEREO mode.

Enjoying the Dolby Virtual sound feature

The Dolby® Virtual sound feature allows you to enjoy virtual surround sound from the TV's speakers.

- If you connect a device (a game console, a DVD player or a DTV receiver, etc.) with analog audio output to standard (analog) audio terminals on the TV, and the input source is encoded with Dolby Surround  sound or Dolby Digital  sound, the Dolby Virtual feature functions as Virtual Dolby Surround  (VDS). VDS simulates Dolby Surround sound from the TV's speakers.

To turn on the Dolby Virtual sound feature:

1. Press MENU, and then press ◀ or ▶ until the THEATER menu appears.
2. Press ▲ or ▼ to highlight Dolby Virtual.
3. Press ◀ or ▶ to highlight ON.

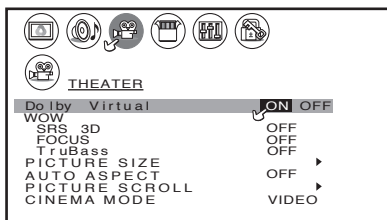

To turn off the Dobby Virtual sound feature:

Highlight OFF in step 3 above.

Enjoying the WOW™ surround sound feature

The WOW™ surround sound features (SRS 3D, FOCUS and TruBass) expand the audio listening field wider and deeper to create exceptional sound quality from the TV's speakers. The WOW features use stereo signals from a TV broadcast or video input.

- SRS 3D — Surround sound effect
- FOCUS — Vocal emphasis effect
- TruBass — Bass expansion level (HIGHT, LOW, or OFF)

To adjust the WOW feature:

1. Select STEREO mode (See “Selecting stereo/SAP broadcasts” on page 54).
2. Press MENU, and then press ◀ or ▶ until the THEATER menu appears.
3. Press ▲ or ▼ to highlight the desired WOW feature you want to adjust (SRS 3D, FOCUS, or TruBass), and then press ◀ or ▶ to adjust the item.

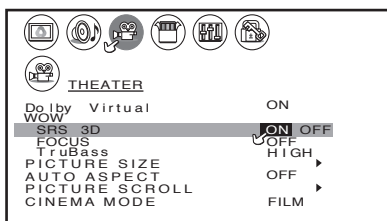

Note:

The Dolby Virtual and SRS 3D features cannot be on at the same time.

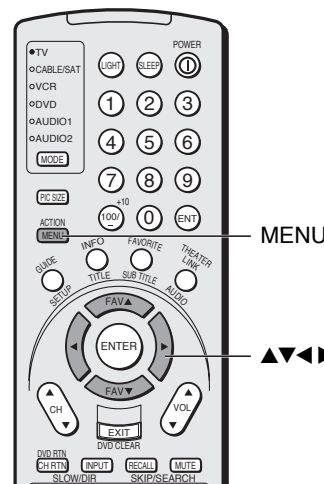

Adjusting the sound quality

You can change the quality of your TV's sound by adjusting the bass, treble, and balance.

To adjust the sound quality:

1. Press MENU, and then press ◀ or ▶ until the AUDIO menu appears.
2. Press ▲ or ▼ to highlight the item you want to adjust (BASS, TREBLE, or BALANCE).

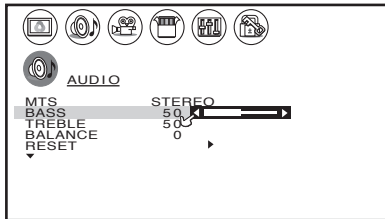

3. Press ◀ or ▶ to adjust the level.
 - ◀ makes the sound quality weaker or decreases the balance in the right channel, depending on the item selected.
 - ▶ makes the sound quality stronger or decreases the balance in the left channel, depending on the item selected.

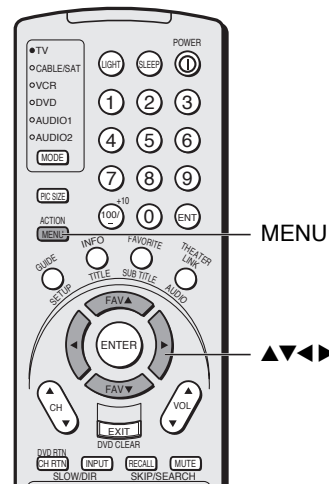

Resetting your audio adjustments

The RESET function returns your audio adjustments to the following factory settings:

- Bass center (50)
- Treble center (50)
- Balance center (0)

To reset your audio adjustments:

1. Press MENU, and then press ◀ or ▶ until the AUDIO menu appears.
2. Press ▲ or ▼ to highlight RESET.
3. Press ◀ or ▶. The menu displays “DONE.”

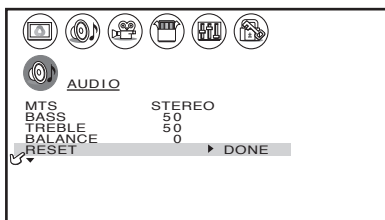

Using the sub-bass system (SBS)

The sub-bass system allows you to enhance bass performance, even when the volume is low.

To turn on the SBS:

1. Press MENU, and then press ◀ or ▶ until the AUDIO menu appears.
2. Press ▲ or ▼ to highlight SBS.
3. Press ◀ or ▶ to highlight ON.

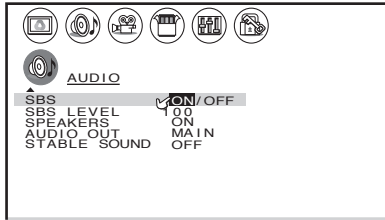

To adjust the SBS level:

4. Press ▲ or ▼ to highlight SBS LEVEL.
5. Press ◀ or ▶ to adjust the SBS level.

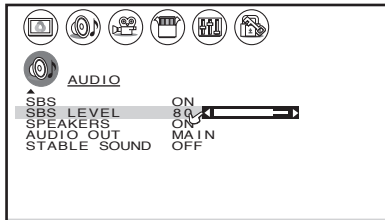

To turn off the SBS:

Highlight OFF in step 3 above.

Turning off the built-in speakers

Use this feature to turn the TV speakers off when you connect an audio system (see "Connecting an audio system" on page 18).

To turn off the built-in speakers:

1. Press MENU, and then press ◀ or ▶ until AUDIO menu appears.
2. Press ▲ or ▼ to highlight SPEAKERS.
3. Press ◀ or ▶ to highlight OFF.

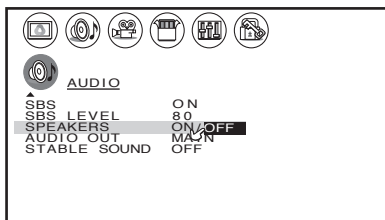

To turn on the built-in speakers:

Highlight ON in step 3 above.

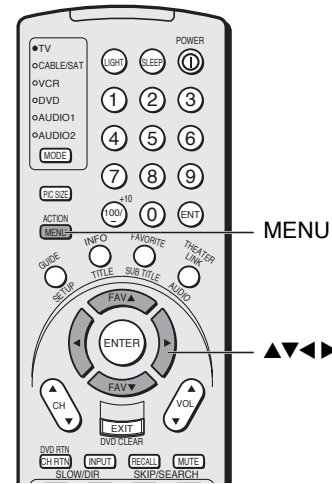

Note:

The SBS signal does not pass through the "Variable Audio OUT" jacks (see "Connecting an audio system" on page 17).

Selecting the Audio OUT sound

This feature allows you to select the sound source (MAIN or POP) that is output from the AUDIO OUT terminals.

This is useful when amplifying or recording the POP sound with external equipment while hearing the sound of the main picture through the built-in speakers. See “Connecting an audio system” on page 17.

To select the Audio OUT sound:

1. Press MENU, and then press ◀ or ▶ until the AUDIO menu appears.
2. Press ▲ or ▼ to highlight AUDIO OUT.
3. Press ◀ or ▶ to select MAIN or POP.

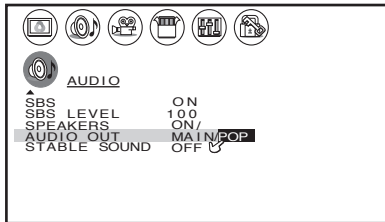

- MAIN: Outputs the sound of the main program through the AUDIO OUT terminals.
- POP: Outputs the sound of the POP program through the AUDIO OUT terminals.

Using the StableSound® feature

The StableSound® feature limits the highest volume level to prevent extreme changes in volume when the signal source is changed (for example, to prevent the sudden increase in volume that often happens when a TV program switches to a commercial).

To turn on the StableSound® feature:

1. Press MENU, and then press ◀ or ▶ until the AUDIO menu appears.
2. Press ▲ or ▼ to highlight STABLE SOUND.
3. Press ◀ or ▶ to select ON.

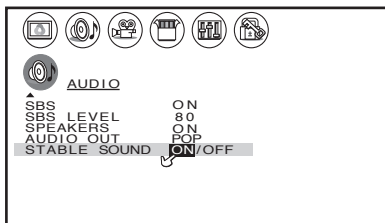

To turn off the StableSound® feature:
Highlight OFF in step 3 above.

Note:

Make sure the volume control of your audio amplifier is set to a moderate listening level.

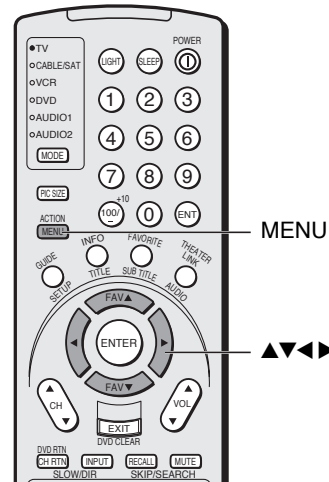

Note:

When the POP is not on the screen, the sound of the main program is output, even if the POP sound is selected.

Selecting the gray level of the side panels

Select the gray level to prevent permanent after-image of the boundary lines between the side panels and picture in 4:3 mode.

To select the gray level:

1. Press MENU, and then press ◀ or ▶ until the SET UP menu appears.
2. Press ▲ or ▼ to highlight GRAY LEVEL.

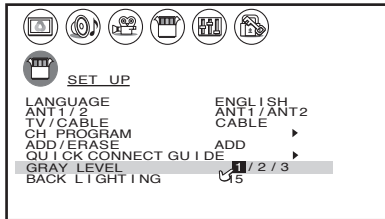

3. Press ◀ or ▶ to select the gray level from 1, 2 or 3.
 - 1: Dark gray
 - 2: Mid gray
 - 3: Light gray

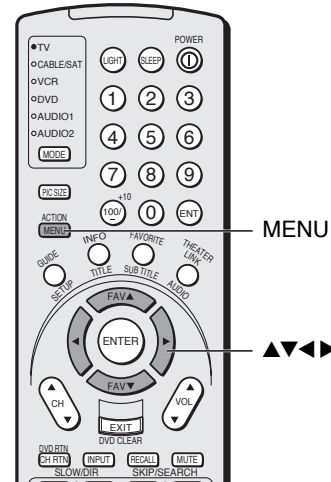

Adjusting the back lighting feature

If you are in bright environment, you may feel difficulty to watch the screen on your TV. At that time, you may improve the clarity on the screen with adjusting the back lighting feature.

To adjust the back lighting:

1. Press MENU, and then press ◀ or ▶ until the SET UP menu appears.
2. Press ▲ or ▼ to highlight BACK LIGHTING.

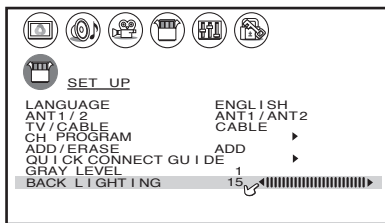

3. Press ◀ or ▶ to adjust the screen brightness.

Note:

- The cold cathode fluorescent lamp used for the back light on this TV has longevity. When the brightness of the screen comes down, or the flickers of the screen are caused, or some parts of the screen do not light up, it may reach the end of its life.
- When you just buy and start to use this TV, the flickering may cause in the screen. In this case, switch off the TV, then switch on it again to recover the condition.

Displaying on-screen information

Press **RECALL** to display the following information on-screen:

- Antenna mode (when in TV mode)
- Channel number or video mode selected
- Remaining time of ON/SLEEP time (if set)
- Channel label (if set)
- Stereo or SAP audio status
- V-CHIP rating status
- Picture size

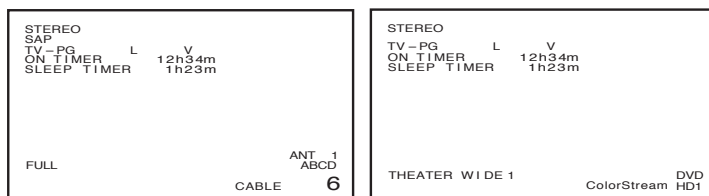

Viewing the demonstration mode

The demonstration mode will demonstrate several of your TV's features.

To start the demo:

Press and hold **MENU** on the TV control panel for 4 seconds.

To stop the demo:

Press **RECALL**, **EXIT**, or **POWER**.

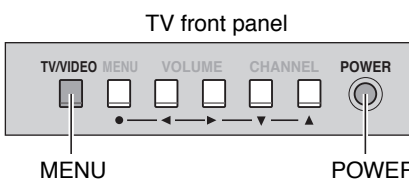

Understanding the auto power off feature

The TV will automatically turn itself off after approximately 15 minutes if it is tuned to a vacant channel or a station that completes its broadcast for the day. This feature does not work in VIDEO mode.

Understanding the last mode memory feature

If the power is cut off while you are viewing the TV, the Last Mode Memory feature turns on the TV automatically when the power is resupplied.

If the power is going to be off for a long time and you are going to be away from your TV, unplug the power cord to prevent the TV from turning on in your absence.

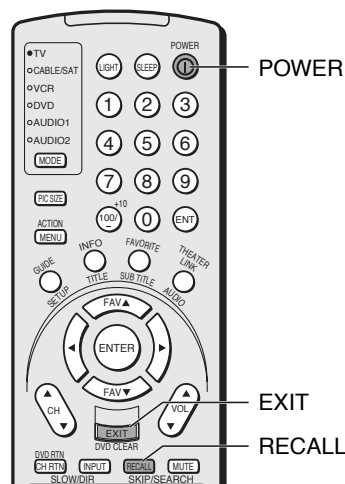

Appendix

Specifications

- **Design and specifications are subject to change without notice.**
- **Never service or remodel the TV set by yourself. It may expose you to a fire hazard or dangerous voltage.**

Television System
NTSC standard

Channel Coverage
VHF: 2 through 13
UHF: 14 through 69
Cable TV: Mid band (A-8 through A-1, A through I)
Super band (J through W)
Hyper band (AA through ZZ, AAA, BBB)
Ultra band (65 through 94, 100 through 125)

Power Source
110-240 V AC, 50/60 Hz (See page 3.)

Power Consumption
150 W (average)

Audio Power
10 W + 10 W

Speaker Type
Four 2 × 3-1/2 inches (50 × 90 mm)

Video/Audio Terminals
S-VIDEO INPUT
Y : 1 V(p-p), 75 ohm, negative sync.
C : 0.286 V(p-p) (burst signal), 75 ohm
VIDEO/AUDIO INPUT
VIDEO: 1 V(p-p), 75 ohm, negative sync.
AUDIO: 150 mV(rms) (30% modulation equivalent, 47k ohm)
ColorStream® (component video) INPUT
Y : 1V(p-p), 75 ohm
PR: 0.7 V(p-p), 75 ohm
PB: 0.7 V(p-p), 75 ohm
AUDIO: 150 mV(rms), 47k ohm
VIDEO/AUDIO OUTPUT
VIDEO: 1 V(p-p), 75 ohm, negative sync.
AUDIO: 150 mV(rms) (30% modulation equivalent, 4.7k ohm)
VARIABLE AUDIO OUTPUT
0–300 mV(rms) (30% modulation equivalent, 4.7k ohm)
DVI/HDCP INPUT
HDCP compliant
E-EDID* 1.3 compliant
DVI-D uncompressed, high-speed, digital single-link connection
Suggested input scan rates: 1080i, 720p, 480p, 480i
Headphones jack
3.5 mm stereo

TheaterLink
OUTPUT: 3 V(p-p), 10k ohm

Dimensions
Width : 32-9/32 inches (820 mm)
Height : 18-37/64 inches (472 mm)
Depth : 5-25/64 inches (137 mm)

Mass (weight)
47.8 lbs (21.7 kg)

Operating condition
Temperature: 32°F – 95°F (0°C – 35°C)
Humidity: 20 – 80% (No moisture condensation)

Exemptions

TACP/THI/TCL are not liable for:

- (1) damage caused by fires, natural disaster (such as thunder, earthquake, etc.), use by third person, accidents, owner's misuse, or use in other improper conditions;
- (2) incidental damages (such as profit loss or interruption in business, modification or erasure of record data, and so forth) caused by use or misuse of this product;
- (3) damage caused by neglect of the instructions described in the owner's manual; and
- (4) damage caused by misuse or malfunction through simultaneous use of this product and the connected equipment.

*E-EDID = Enhanced-Extended Display Identification

Troubleshooting

Before calling a service technician, please check the following table for a possible cause of the problem and some solutions.

Problem	Solution
TV will not turn on	<ul style="list-style-type: none">• Make sure the power cord is plugged in, then press POWER.• The remote control batteries may be dead. Replace the batteries.
No picture, no sound	<ul style="list-style-type: none">• Check the antenna/cable connections.
No sound, picture OK	<ul style="list-style-type: none">• The sound may be muted. Press VOLUME.• The station may have broadcast difficulties. Try another channel.• Check that the SPEAKERS function in AUDIO menu is set properly.
Poor picture, sound OK	<ul style="list-style-type: none">• Check the antenna connections.• The station may have broadcast difficulties. Try another channel.• Adjust the PICTURE menu.
Poor reception of broadcast channels	<ul style="list-style-type: none">• The station may have broadcast difficulties. Try another channel.• Check the antenna connections.• If you are using a VCR, make sure the TV/VCR button is set correctly.
Cannot receive above channel 13	<ul style="list-style-type: none">• Make sure the TV/CABLE switch is set to the mode that corresponds with the signal source type (cable company or outside antenna).
Black box appears on the screen	<ul style="list-style-type: none">• The closed caption feature may be set to one of the Text modes (T1, T2, T3, or T4). Turn closed captioning OFF.
Unable to select a certain channel	<ul style="list-style-type: none">• The channel may be locked out with the CH LOCK feature, or erased with the ADD/ERASE feature.
Multiple images	<ul style="list-style-type: none">• The station may have broadcast difficulties. Try another channel.• Antenna reception may be poor. Use a highly directional outdoor antenna.
Poor color or no color	<ul style="list-style-type: none">• The station may have broadcast difficulties. Try another channel.• Adjust the TINT and/or COLOR in the PICTURE menu.
No stereo or SAP sound from a known MTS broadcast	<ul style="list-style-type: none">• Make sure the MTS feature is set properly.
The front panel buttons do not operate	<ul style="list-style-type: none">• Check the FRONT PANEL LOCK feature.
The remote control does not operate	<ul style="list-style-type: none">• Check whether the appropriate device mode is selected.• Remove all obstructions between the remote control and the remote control sensor in the TV.• The remote control batteries may be dead. Replace the batteries.
Cannot access signal input sources (Video1, Video2, Video3, ColorStream HD1/HD2, DVI/HDCP) and/or Channels 3 and 4.	<ul style="list-style-type: none">• Check the VIDEO LOCK feature.

Limited United States Warranty for LCD TV

Toshiba America Consumer Products, Inc. ("TACP") and Toshiba Hawaii, Inc. ("THI") make the following limited warranties to original consumers in the United States.

THESE LIMITED WARRANTIES EXTEND TO THE ORIGINAL CONSUMER PURCHASER OR ANY PERSON RECEIVING THIS LCD TV AS A GIFT FROM THE ORIGINAL CONSUMER PURCHASER AND TO NO OTHER PURCHASER OR TRANSFEREE.

PRODUCTS PURCHASED IN THE U.S.A. AND USED IN CANADA ARE NOT COVERED BY THESE WARRANTIES.

PRODUCTS PURCHASED IN CANADA AND USED IN THE U.S.A. ARE NOT COVERED BY THESE WARRANTIES.

Limited One (1) Year Warranty on Parts and Labor*

TACP/THI warrant this lcd tv and its parts against defects in materials or workmanship for a period of one (1) year after the date of original retail purchase. DURING THIS PERIOD, TACP/THI WILL, AT TACP/THI'S OPTION, REPAIR OR REPLACE A DEFECTIVE PART WITH A NEW OR REFURBISHED PART WITHOUT CHARGE TO YOU FOR PARTS OR LABOR. TACP/THI Authorized Service Station personnel will come to your home when warranty service is required. Depending on the type of repair required, either the service will be performed in your home or the set will be taken to the TACP/THI Authorized Service Station for repair and returned to your home at no cost to you.

Rental Units

The warranty for rental units begins with the date of first rental or thirty (30) days from the date of shipment to the rental firm, whichever comes first.

*Commercial Units

Lcd tvs sold and used for commercial purposes have a limited ninety (90) day warranty for all parts, labor.

Owner's Manual and Product Registration Card

Read this owner's manual thoroughly before operating this lcd tv. Complete and mail the enclosed product registration card within ten days after you, or the person who has given you this product as a gift, purchased this lcd tv. Returning the product registration card will enable TACP/THI to provide you with better customer service and improved product support. Failure to return the product registration card will not affect your rights under this warranty.

Your Responsibility

THE ABOVE WARRANTIES ARE SUBJECT TO THE FOLLOWING CONDITIONS:

- (1) You must provide your bill of sale or other proof of purchase.
- (2) All warranty servicing of this lcd tv must be made by an Authorized TACP/THI Service Station.
- (3) The warranties from TACP and THI are effective only if the lcd tv is purchased and operated in the U.S.A. or Puerto Rico.
- (4) Labor service charges for set installation, setup, adjustment of customer controls, and installation or repair of antenna systems are not covered by these warranties. Reception problems caused by inadequate antenna systems are your responsibility.
- (5) Warranties extend only to defects in materials or workmanship as limited above and do not extend to any lcd tv or parts that have been lost or discarded by you or to damage to lcd tv or parts caused by misuse, accident, Acts of God (such as lightning or fluctuations in electric power), improper installation, improper maintenance, or use in violation of instructions furnished by TACP/THI; or to units that have been modified or had the serial number removed, altered, defaced, or rendered illegible.

How to Obtain Warranty Services

If, after following all of the operating instructions in this manual and checking the "Troubleshooting" section, you find that service is needed:

- (1) To find the nearest TACP/THI Authorized Service Station:

For lcd tvs purchased in the United States, except Hawaii, visit TACP's web site at www.toshiba.com/tacp, or call toll free 1-800-631-3811.

For lcd tvs purchased in Hawaii, contact Toshiba Hawaii, Inc., 327 Kamakee Street, Honolulu, HI 96814, (808)591-9281.

- (2) Present your bill of sale or other proof of purchase to the Authorized Service Station. Authorized TACP/THI Service Station personnel will come to your home when warranty service is required. Depending on the type of repair required, either the service will be performed in your home or the set will be taken to the Authorized Service Station for repair and returned to your home at no cost to you.

**For additional information, visit TACP's web site:
www.toshiba.com/tacp.**

ALL WARRANTIES IMPLIED BY THE LAW OF ANY STATE OF THE U.S.A., INCLUDING THE IMPLIED WARRANTIES OF MERCHANTABILITY AND FITNESS FOR A PARTICULAR PURPOSE, ARE EXPRESSLY LIMITED TO THE DURATION OF THE LIMITED WARRANTIES SET FORTH ABOVE. WITH THE EXCEPTION OF ANY WARRANTIES IMPLIED BY THE LAW OF ANY STATE OF THE U.S.A. AS HEREBY LIMITED, THE FOREGOING WARRANTY IS EXCLUSIVE AND IN LIEU OF ALL OTHER WARRANTIES, GUARANTEES, AGREEMENTS, AND SIMILAR OBLIGATIONS OF TACP OR THI WITH RESPECT TO THE REPAIR OR REPLACEMENT OF ANY PARTS. IN NO EVENT SHALL TACP OR THI BE LIABLE FOR CONSEQUENTIAL OR INCIDENTAL DAMAGES.

No person, agent, distributor, dealer, or company is authorized to change, modify, or extend the terms of these warranties in any manner whatsoever. The time within which action must be commenced to enforce any obligation of TACP or THI arising under this warranty or under any law of the United States or of any state thereof is hereby limited to 90 days from the date you discover, or should have discovered, the defect. This limitation does not apply to implied warranties arising under the law of any state of the U.S.A..

THIS WARRANTY GIVES YOU SPECIFIC LEGAL RIGHTS, AND YOU MAY ALSO HAVE OTHER RIGHTS, WHICH MAY VARY FROM STATE TO STATE IN THE U.S.A. SOME STATES OF THE U.S.A. DO NOT ALLOW LIMITATIONS ON THE DURATION OF AN IMPLIED WARRANTY, LIMITATIONS ON THE TIME WITHIN WHICH AN ACTION MAY BE BROUGHT, OR THE EXCLUSION OR LIMITATION OF INCIDENTAL OR CONSEQUENTIAL DAMAGES; THEREFORE, THE ABOVE LIMITATIONS OR EXCLUSIONS MAY NOT APPLY TO YOU UNDER SUCH CIRCUMSTANCES.

FST PURE® is a registered trademark of Toshiba America Consumer Products, Inc.
REV. MAR02

Limited Canada Warranty for LCD TV

Toshiba of Canada Limited ("TCL") makes the following limited warranties to original consumers in Canada.

THESE LIMITED WARRANTIES EXTEND TO THE ORIGINAL CONSUMER PURCHASER OR ANY PERSON RECEIVING THIS LCD TV AS A GIFT FROM THE ORIGINAL CONSUMER PURCHASER AND TO NO OTHER PURCHASER OR TRANSFEREE.

PRODUCTS PURCHASED IN THE U.S.A. AND USED IN CANADA ARE NOT COVERED BY THESE WARRANTIES.

PRODUCTS PURCHASED IN CANADA AND USED IN THE U.S.A. ARE NOT COVERED BY THESE WARRANTIES.

Limited One (1) Year Warranty on Parts and Labor*

TCL warrants this lcd tv and its parts against defects in materials or workmanship for a period of one (1) year after the date of original retail purchase. DURING THIS PERIOD, TCL WILL, AT TCL'S OPTION, REPAIR OR REPLACE A DEFECTIVE PART WITH A NEW OR REFURBISHED PART WITHOUT CHARGE TO YOU FOR PARTS OR LABOR. TCL Authorized Service Depot personnel will come to your home when warranty service is required. Depending on the type of repair required, either the service will be performed in your home or the set will be taken to the TCL Authorized Service Depot for repair and returned to your home at no cost to you. IN-HOME SERVICE ONLY APPLIES WITHIN 100 KILOMETERS OF AN AUTHORIZED TCL SERVICE DEPOT.

Rental Units

The warranty for rental units begins with the date of first rental or thirty (30) days from the date of shipment to the rental firm, whichever comes first.

*Commercial Units

Lcd tvs sold and used for commercial purposes have a limited ninety (90) day warranty for all parts, labor.

Owner's Manual

Read this owner's manual thoroughly before operating this lcd tv.

Your Responsibility

THE ABOVE WARRANTIES ARE SUBJECT TO THE FOLLOWING CONDITIONS:

- (1) You must provide your bill of sale or other proof of purchase.
- (2) All warranty servicing of this lcd tv must be made by an Authorized TCL Service Depot.
- (3) The warranties from TCL are effective only if the lcd tv is purchased in Canada from an authorized TCL dealer and operated in Canada.
- (4) Labor service charges for set installation, setup, adjustment of customer controls, and installation or repair of antenna systems are not covered by these warranties. Reception problems caused by inadequate antenna systems are your responsibility.
- (5) Warranties extend only to defects in materials or workmanship as limited above and do not extend to any lcd tv or parts that have been lost or discarded by you or to damage to LCD TV or parts caused by misuse, accident, Acts of God (such as lightning or fluctuations in electric power), improper installation, improper maintenance, or use in violation of instructions furnished by TCL; or to units that have been modified or had the serial number removed, altered, defaced, or rendered illegible.

How to Obtain Warranty Services

If, after following all of the operating instructions in this manual and checking the "Troubleshooting" section, you find that service is needed:

- (1) To find the nearest TCL Authorized Service Depot, visit TCL's web site: www.toshiba.ca.
- (2) Present your bill of sale or other proof of purchase to the Authorized Service Depot. Authorized TCL Service Depot personnel will come to your home when warranty service is required. Depending on the type of repair required, either the service will be performed in your home or the set will be taken to the Authorized Service Depot for repair and returned to your home at no cost to you. IN-HOME SERVICE ONLY APPLIES WITHIN 100 KILOMETERS OF AN AUTHORIZED TCL SERVICE DEPOT.

**For additional information, visit TCL's web site:
www.toshiba.ca**

ALL WARRANTIES IMPLIED BY THE LAW OF ANY PROVINCE OF CANADA, INCLUDING THE IMPLIED WARRANTIES OF MERCHANTABILITY AND FITNESS FOR A PARTICULAR PURPOSE, ARE EXPRESSLY LIMITED TO THE DURATION OF THE LIMITED WARRANTIES SET FORTH ABOVE. WITH THE EXCEPTION OF ANY WARRANTIES IMPLIED BY THE LAW OF ANY PROVINCE OF CANADA AS HEREBY LIMITED, THE FOREGOING WARRANTY IS EXCLUSIVE AND IN LIEU OF ALL OTHER WARRANTIES, GUARANTEES, AGREEMENTS, AND SIMILAR OBLIGATIONS OF TCL WITH RESPECT TO THE REPAIR OR REPLACEMENT OF ANY PARTS. IN NO EVENT SHALL TCL BE LIABLE FOR CONSEQUENTIAL OR INCIDENTAL DAMAGES.

No person, agent, distributor, dealer, or company is authorized to change, modify, or extend the terms of these warranties in any manner whatsoever. The time within which action must be commenced to enforce any obligation of TCL arising under this warranty or under any law of Canada or of any province thereof, is hereby limited to 90 days from the date you discover, or should have discovered, the defect. This limitation does not apply to implied warranties arising under the law of any province of Canada.

THIS WARRANTY GIVES YOU SPECIFIC LEGAL RIGHTS, AND YOU MAY ALSO HAVE OTHER RIGHTS, WHICH MAY VARY FROM PROVINCE TO PROVINCE IN CANADA. SOME PROVINCES OF CANADA DO NOT ALLOW LIMITATIONS ON THE DURATION OF AN IMPLIED WARRANTY, LIMITATIONS ON THE TIME WITHIN WHICH AN ACTION MAY BE BROUGHT, OR THE EXCLUSION OR LIMITATION OF INCIDENTAL OR CONSEQUENTIAL DAMAGES; THEREFORE, THE ABOVE LIMITATIONS OR EXCLUSIONS MAY NOT APPLY TO YOU UNDER SUCH CIRCUMSTANCES.

FST PURE® is a registered trademark of Toshiba America Consumer Products, Inc.
REV. MAR02

Index

A B

ANT 1/2 29
 Antenna cables 9
 AUDIO OUT sound, selecting 59
 Audio system connection 18
 Auto aspect 38
 Auto power off 62
 A/V cables 9
 Back lighting 59
 Back of the TV 8

C

Cable converter box connection 10
 Camcorder connection 15
 CH ▲▼ buttons 30
 Channel surf mode (SpeedSurf) 31
 CH LABEL 34
 CH LOCK 46
 CH RTN button 32
 Channel Number buttons 31
 Channel programming
 ADD/ERASE 31
 Automatic programming 30
 TV/CABLE selection 30
 CH SCAN button 41
 Cinema mode 38
 Closed caption 53
 Color temperature 50
 Component video cables 9

D

Demonstration mode 62
 Doby Virtual sound 56
 Double-window ("POP") feature 39
 DNR (Digital Noise Reduction) 50
 DTV receiver connection 14
 DVD connection 12, 13
 DVI/HDCP connection 16

F G I

FAV ▼▲ buttons 33
 FAVORITE button 42
 Favorite channels 32
 Favorite channel search 42
 FOCUS 56
 Front of the TV 8
 Front panel lock 48
 Game timer 48
 Gray level 59
 INPUT button 29, 51

L M

Labeling channels 34
 Labeling video inputs 52
 Language selection 29
 Last mode memory 62
 Locking channels 46
 Locking video inputs 47
 LOCK menu 43
 Menu system 27
 MTS feature 55
 MUTE button 55

O P Q

ON-timer 54
 Picture adjustments
 COLOR TEMPERATURE 50
 Picture mode 49
 Picture quality 51
 Picture-out-picture (POP)
 POP CH ▲▼ buttons 39
 SOURCE button 39
 FREEZE button 40
 SWAP button 40
 Picture scroll 37
 Picture size selection 35
 Quick connect guide 28

R

RECALL button 62
 Remote control
 Battery installation 19
 Device code table 24-25
 Functional key chart 20-21
 Learning about the buttons 26
 Operational feature reset 23
 Programming 22
 Volume Lock feature 23
 RESET 51, 57

S

S-video cables 9
 SAP sound 55
 Satellite receiver connection 12
 Scrolling the Theater Wide picture 37
 Set-top box 14
 Sleep timer 54
 Sound quality adjustments 57
 SPEAKERS on/off 58
 Specifications 63
 SpeedSurf 31
 SRS 3D 56
 StableSound® 59
 Stereo sound 55
 Sub-bass system (SBS) 58
 SurfLock™ 32

T

TheaterLink connection 17
 Troubleshooting 64
 TruBass feature 56
 TV/VIDEO button 29, 51

V

V-CHIP
 BLOCKING OPTION 45
 ENABLE BLOCKING 44
 MPAA RATING 45
 NEW PIN CODE 48
 TV RATING 44
 Unlocking programs temporarily 46
 VCR connection 10, 11-15
 VIDEO LABEL 52
 VIDEO LOCK 47

W

Warranty 65
 WOW feature 56

TOSHIBA AMERICA CONSUMER PRODUCTS, INC.

HEAD OFFICE/82 TOTOWA ROAD, WAYNE, NEW JERSEY 07470
NATIONAL SERVICE DIVISION:1420B TOSHIBA DRIVE, LEBANON, TN. 37087

TOSHIBA HAWAII, INC.

HEAD OFFICE/327 KAMAKEE STREET, HONOLULU, HAWAII 96814, U.S.A. TEL: (808) 591-9281

TOSHIBA OF CANADA LTD.

HEAD OFFICE/191 McNABB STREET MARKHAM, ONTARIO L3R 8H2, CANADA TEL: (905) 470-5400
SERVICE CENTERS/TORONTO: 191 McNABB STREET MARKHAM, ONTARIO L3R 8H2, CANADA TEL: (905) 470- 5400
MONTREAL: 1643, NORTH SERVICE RD., TRANS-CANADA HIGHWAY, DORVAL QUEBEC, H9P 1J1, CANADA
TEL: (514) 856-4100
VANCOUVER: 22171 FRASERWOOD WAY, RICHMOND, B.C. V6W 1J5, CANADA TEL: (604) 303-2500

MANUFACTURED BY

TOSHIBA VISUAL-EQUIPMENT CORPORATION

ColorStream and StableSound are registered trademarks of Toshiba America Consumer Products.
SurfLock is trademark of Toshiba America Consumer Products, Inc.

Dolby and the double-D symbol are registered trademarks of Dolby Laboratories. Manufactured under license from Dolby Laboratories.

WOW and the (●) symbol are trademarks of SRS Labs, Inc.

WOW technology is incorporated under license from SRS Labs, Inc.

Printed in Japan
(03-08)

TOSHIBA

23566134